

Proposed Control Methods of Power Electronic Interfaces in Wind Generation System

Bechir Bouaziz ^{#1}, Faouzi Bacha ^{#2}, Moncef Gasmi ^{#3}

[#]Computer Laboratory for Electrical Systems, INSAT, University of Carthage,

Centre Urbain Nord BP 676 - 1080 Tunis Cedex, Tunis, Tunisia

¹bechir.bouaziz@isimg.rnu.tn

²Faouzi.Bacha@esstt.rnu.tn

³m.gsm@enit.rnu.tn

Abstract— recently, in energy sustainable, attention has been drawn to controlling the power electronics in renewable energy system. This paper is focused to the proposal a main control algorithm based on an advanced control strategy to control the instantaneous powers of a voltage source inverter for a Variable speed wind generation system (VSWGS). The DC/AC power conversion has been managed out using the proposed instantaneous power controller based on sliding mode approach. In this study, we are focused on validation of the proposed control methods, the performance and power quality of the voltage source inverter. Modelling and control design of the VSWGS with the proposed control strategies is performed by using MATLAB/Simulink. The experimental tests are verified on the dSPACE DS1104 based experimental prototype. The results show that the electrical and mechanical parameters of VSWGS reach to desirable operation values in a very short time. In addition, the THD of injected current is 3.2%.

Keywords— Wind generation system, power electronics interface, sliding mode approach, instantaneous powers,

I. INTRODUCTION

The renewable energy sources are geographically distributed and commonly connected to the distribution grid. The power electronics plays a crucial role in the integration for example of the variable-speed wind power into the power generation system [1]-[2]. Because of its advantages and recent technological advancements in wind turbine aerodynamics and power electronic interfaces, wind energy is considered to be an excellent renewable energy source. Research to extract the maximum power out of wind energy is attractive. In addition to increasing the energy capture, modern wind turbines include mechanical actuators with the aim of having control of the blade pitch angle [3]. Pitch control is commonly meant to limit the captured power above rated wind speed. Therefore, in order to have control on the voltage and the power flows simultaneously, different techniques for the back-to-back voltage source converters have been developed [4]-[5].

Generally, the control techniques which are commonly used could be classified as direct or indirect control strategies. The indirect-control type Voltage Oriented Control (VOC) is mainly used [6]-[7]. Indirect control strategies generally lead

to good transient behavior and acceptable steady-state operation. They operate at a constant switching frequency (CSF).

Considering discrete operation of the voltage source inverters, the direct power control (DPC) has been paid much attention for its simple structure, fast dynamic response under transient conditions. Recently, the DPC strategies have also been developed to control the electronics power interface used in the wind generation systems [8]-[9]. The methods were based on an optimal switching table by using the information of estimated rotor flux and stator flux [10]. The main disadvantage of the DPC strategy is the resulting variable switching frequency.

As the grid-connected voltage source inverter (VSI) is a variable structure system, it is by nature a candidate for the Sliding Mode Control (SMC) strategy. Its application is to provide an SMC law and the PWM pattern for controlling the power electronics converters [11]. A combination of methods and strategies results in diverse control concepts used to control the grid connected VSI. Such, the mixed of direct power control (DPC) and space vector modulation (SVM) approach is presented in reference [12]-[13] for DC/AC converter. Sliding-control type approach is combined with predictive computing of voltage application times to control the two and multilevel level voltage source converter [14]. The direct active and reactive power regulation is tested on a grid connected DC/AC converter system using sliding mode control approach.

In this paper, design and control strategies of AC-DC-AC PWM power converter by using sliding mode controller is realized for variable-speed wind generation system (VSWGS) at the rated power 300kW. The inverter part of the VSWGS has been designed with a two level inverter, while the rectifier part has been constituted with controlled AC-DC PWM converter. The main objective of the proposed control methods is to extract maximum available energy from the wind turbine and as well as to obtained the generator reference electromagnetic torque by the proposed MPPT control method. In high wind speed, the mechanical power is controlled by the proposed pitch control method. In order to have control on the voltage and the power flows simultaneously, direct torque control strategy is used to control the stator flux and

electromagnetic torque of the generator and the instantaneous power control strategy is used to control and manage the instantaneous powers.

The experimental and simulation results show that the control objectives are accomplished controls, within of steady state and transient conditions.

II. DESCRIPTION OF THE WIND GENERATION SYSTEM

The most generalized form of power electronics topology for the wind energy application is the back-to-back rectifier/inverter connection which provides the improved power flow control as well as increased efficiency. The voltage-fed converter scheme used in such systems is a PWM-based IGBT bridge rectifies the variable-frequency variable-voltage power from the wind generator. The rectifier also supplies the excitation needs for the induction generator. The inverter topology is identical to that of the rectifier, and it supplies the generated power at 50 Hz to the utility grid.

For the induction generator based wind system, this power electronics topology is necessary for utility connection. Based on the control design for the back-to-back PWM converter system, various advantages can be obtained such as:

- The line-side power factor is unity with no harmonic current injection.
- Continuous power generation from zero to the highest turbine speed is possible.
- Power can flow in either direction

III. DESIGN AND CONTROL POWER ELECTRONICS

In the electric generation system that contains variable-speed wind tribunes, there exist three components. These are wind turbine, generator, and power converter. In this study, in the PWM power converter circuit, a two-level voltage source rectifier (VSR) and in the two-level voltage source inverter (VSI) circuit, an IGBT circuit element was used. A block diagram of wind power generation system (WPGS) with power converter is given in Fig. 1.

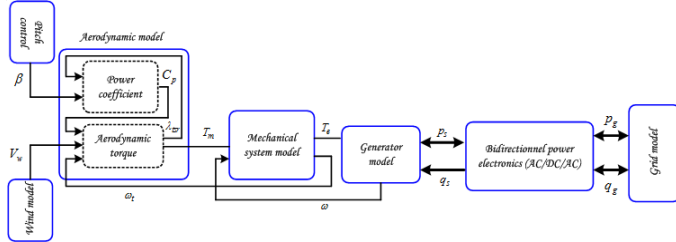

Fig. 1 Block diagram of wind generation system with AC/DC/AC power electronics converter.

A. Control Strategy of voltage source rectifier

In the variable-speed wind energy conversion system, the devices used for AC-DC conversion is the active rectifier, which has a switching circuit topology of AC-DC power conversion. The active rectifier can convert variable frequency and variable voltage to a fixed DC voltage. The generator-side converter controller consists around of a direct torque control (DTC) module. It is well known that the basic concept of DTC based drives is to control both stator flux and electromagnetic

torque simultaneously. In the DTC approach, these reference values are ensured by direct selection of a suitable voltage vector. In the medium scale wind generation system, the generator reference electromagnetic torque is obtained by the MPPT control method proposed.

The mechanical power P_T captured from a wind turbine of a blade radius (R) running in a wind stream of velocity V_w is given by:

$$P_T = \frac{1}{2} \rho \pi R^2 C_p(\lambda, \beta) V_w^3 \quad (1)$$

Where ρ is the air density, C_p is known as the power coefficient of the turbine. The tip speed ratio is the ratio of turbine speed at the tip of a blade to the free stream wind speed and given by:

$$\lambda_{tsr} = \frac{R \omega_T}{V_w} \quad (2)$$

The power coefficient curve has been described in the literature by different fitted equations. In this paper, the power coefficient curve is approximated analytically by

$$C_p(\lambda, \beta) = 0.5109 \left(\frac{116}{X} - 0.4\beta - 5 \right) \exp\left(-\frac{21}{X}\right) + 116\lambda \quad (3)$$

$$\text{With: } X = \frac{1}{\lambda + 0.08\beta} - \frac{0.035}{1 + \beta^3}$$

The power of the turbine is optimized by a maximum power point tracking (MPPT) algorithm. The power coefficient of the turbine is equal to its maximum value. In these conditions the electrical torque at the optimum operating speed is given by:

$$T_e^* = K_m \omega_g^2 \quad (4)$$

With:

The induction generator has been considered as a system which makes it possible to produce electricity from the mechanical energy obtained from the wind. The stator d-q equations of the induction generator in the rotor reference frame are:

$$\begin{cases} v_{sd} = R_s i_{sd} + \frac{d\lambda_{sd}}{dt} - \omega_s \lambda_{sq} \\ v_{sq} = R_s i_{sq} + \omega_s \lambda_{sd} + \frac{d\lambda_{sq}}{dt} \end{cases} \quad (5)$$

In the dq-frame, the expression for electromagnetic torque becomes:

$$T_e = p(\lambda_{sd} i_{sq} - \lambda_{sq} i_{sd}) \quad (6)$$

The equation for mechanical systems for induction generator can be given as:

$$\begin{cases} \frac{d\omega}{dt} = \frac{1}{J}(pT_e - f\omega - T_m) \\ \frac{d\theta}{dt} = \omega \end{cases} \quad (7)$$

The pitch angle controller with the wind turbine is used to limit the output power at the terminal of the induction generator when the wind speed is over the rated speed. The

principle of this method is explained on wind turbine designed for nominal wind speed equal to 12 m/s. Fig.2 describes the model and proposed pitch control strategy used in this study.

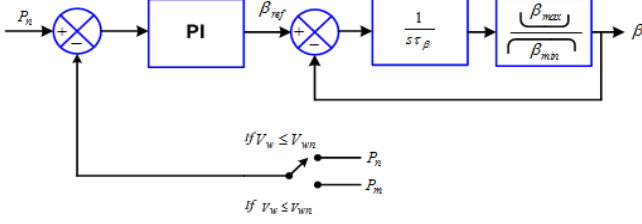

Fig. 2 Model and proposed pitch control

In Fig.3, the detailed block diagram of voltage source rectifier (VSR) converter and the control circuit is given.

The purpose of the DC link voltage controller is to preserve the DC-link voltage at its reference value. The DC-link voltage controller is designed in the continuous time domain.

B. Proposed Control Strategy of voltage source inverter

The proposed power control scheme is used to regulate the instantaneous active and a reactive power of grid-connected voltage source inverter.

The block diagram of the grid or load-side converter control is presented in Fig.3. The control of the grid-connected IGBT-PWM inverter is to combine the conventional DPC strategy, sliding mode control approach (SM), and space vector modulation voltage vector selection technique.

1) *Choice of Sliding Surfaces*: Sliding mode controller enforces the system state on the predefined sliding surface in the system state space by changing her structure of the controller. For this purpose, the sliding surfaces of the proposed controller are set as:

$$\begin{bmatrix} S_p & S_q \end{bmatrix}^T \quad (8)$$

The main idea of the proposed control strategy is to regulate the instantaneous powers of the voltage source inverter. Therefore, the errors between the references and the actual values of instantaneous active and reactive powers are defined as sliding surfaces. In order to maintain the enhanced responses, the switching surfaces can be in the integral forms.

$$S_p = \varepsilon_p + \mu_p \int_0^t \varepsilon_p(t) dt - \varepsilon_p(0)$$

$$S_q = \varepsilon_q + \mu_q \int_0^t \varepsilon_q(t) dt - \varepsilon_q(0) \quad (9)$$

2) *Sliding Mode Control Law*: The sliding mode control (SMC) scheme is suggested to generate the converter output voltage reference as the input to space vector modulation technique module for selected the appropriate control vector. After reaching sliding mode, the derivatives of the sliding surfaces are given by equation (10).

$$\frac{dS_p}{dt} = \frac{d\varepsilon_p}{dt} + \mu_p \varepsilon_p = -\frac{dp_g}{dt} + \mu_p \varepsilon_p \quad (10)$$

$$\frac{dS_q}{dt} = \frac{d\varepsilon_q}{dt} + \mu_q \varepsilon_q = -\frac{dq_g}{dt} + \mu_q \varepsilon_q$$

It is possible to predict the power behavior knowing the instantaneous variations of the active and reactive power, which can be expressed as equations:

$$\frac{dp_g}{dt} = -\frac{3}{2L_g} \left((u_{g\alpha}^2 + u_{g\beta}^2) - (u_{g\alpha}v_{g\alpha} + u_{g\beta}v_{g\beta}) \right) - \frac{R_g}{L_g} p_g - \omega_g q_g \quad (11)$$

$$\frac{dq_g}{dt} = -\frac{3}{2L_g} (u_{g\alpha}v_{g\beta} - u_{g\beta}v_{g\alpha}) - \frac{R_g}{L_g} q_g + \omega_g p_g$$

The condition for the trajectory attraction toward the sliding surface is ensured by a Lyapunov approach. The variation of this function in relation to time must be strictly negative with $S \neq 0$. Therefore, the following control law is selected

$$\begin{bmatrix} v_{g\alpha} \\ v_{g\beta} \end{bmatrix} = -B^{-1} \left\{ \begin{bmatrix} A_p \\ A_q \end{bmatrix} + \begin{bmatrix} \sigma_p & 0 \\ 0 & \sigma_q \end{bmatrix} \begin{bmatrix} \text{sgn}(S_p) \\ \text{sgn}(S_q) \end{bmatrix} \right\} \quad (12)$$

3) *Study of Stability and Robustness*: By setting appropriate switch functions, stability can be achieved provided the following condition is satisfied.

$$\text{If } \begin{cases} S_p \text{sgn}(S_p) > 0 \\ S_q \text{sgn}(S_q) > 0 \end{cases} \text{ then } \frac{dW}{dt} = S^T \frac{dS}{dt} < 0 \quad (13)$$

The time derivative of Lyapunov function is then definitely negative so that the control system becomes asymptotically stable.

The most distinguish property of the variable structure control is the ability to provide the robustness to parametric uncertainty and external disturbances (Acquisition sample errors and measurement noises). The sliding surface will be affected by these disturbances represented by $D = [D_p \ D_q]^T$ and the equation (14) should be rearranged as:

$$\frac{dW}{dt} = S^T \frac{dS}{dt} = S^T \left\{ \begin{bmatrix} D_p \\ D_q \end{bmatrix} - \begin{bmatrix} \sigma_p & 0 \\ 0 & \sigma_q \end{bmatrix} \begin{bmatrix} \text{sgn}(S_p) \\ \text{sgn}(S_q) \end{bmatrix} \right\} \quad (14)$$

If the positive control gains fulfill the following condition $\sigma_p > |D_p|$ and $\sigma_q > |D_q|$, the time derivative of Lyapunov function is definitely negative. Therefore, the robustness is verified by the SMC law.

4) *Remedy of Chattering Phenomenon*: The SMC scheme developed earlier guarantees the fast tracking of instantaneous powers of grid-connected voltage source inverter. Chattering phenomenon is undesirable in practice, since it involves high control activity and further it may excite high frequency dynamics. To eliminate this problem, the discontinuous part of the controller is smoothed out by introducing a boundary layer around the sliding surface. Where “ H ” is the width of the boundary layer and “ j ” represents instantaneous active and reactive power, respectively.

$$\text{sgn}(S_j) = \begin{cases} 1 & \text{if } S_j > H_j \\ \frac{S_j}{H_j} & \text{if } |S_j| \leq H_j \\ -1 & \text{if } S_j < -H_j \end{cases} \quad (15)$$

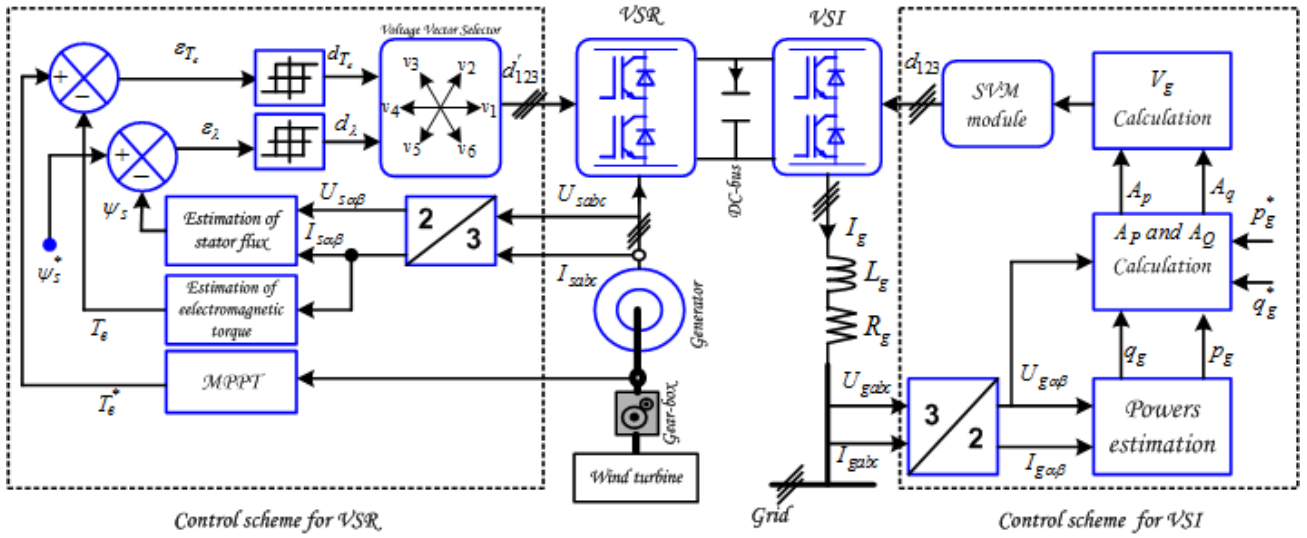

Fig. 3 Control block diagram for power electronics converter in wind generation system with induction generator

IV. SIMULATION RESULTS AND ANALYSIS

In this section, the simulations of the AC/DC voltage source rectifier (VSR) and the wind turbine with control strategies are presented. Simulations have been done using the software MATLAB Simulink. The simulation parameters of the system are given in the form of tables Tab.1 and Tab.2 in Appendix.

Case : Wind speed variation. The wind speed shown in Fig. 4 was considered for the wind turbine. The wind is oscillating around its mean speed (12m/s). Fig. 5 shows the instantaneous active power and reactive power from wind turbine to the point of common coupling to the grid. The average of reactive power is maintained to zero. The pitch control and the maximum power tracking have been accomplished and reacting with a short time. Notice that, a sinusoidal waveform of the current injected to the grid is established.

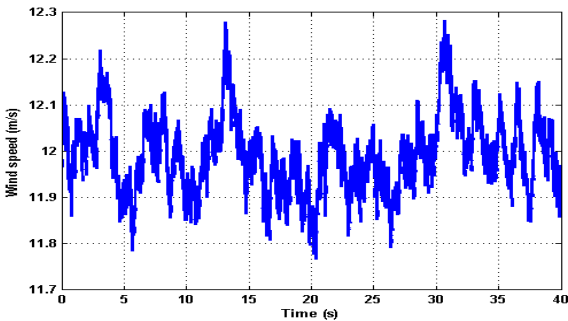
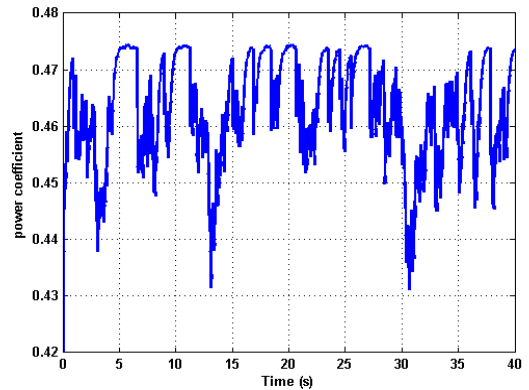
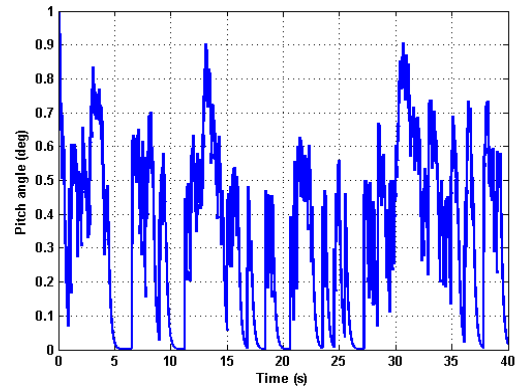

Fig. 4 Wind speed profile



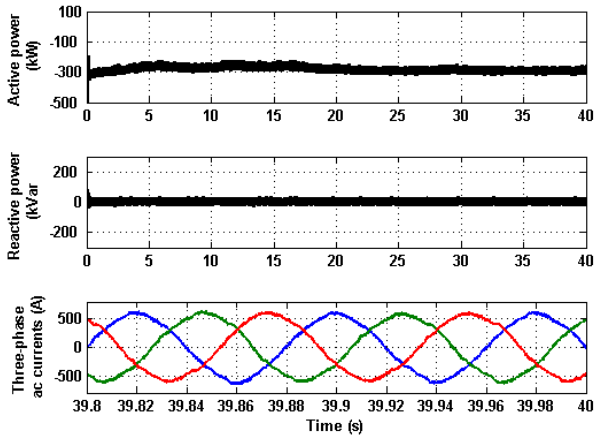

Fig. 5 Simulation behavior of the VSWG to the wind speed variation (turbulent).

V. EXPERIMENTAL RESULTS

Experimental studies of the proposed DPC were carried out on a laboratory of voltage source inverter test bench. The basic experimental parameters have been listed in Tab.3. A photograph of the experimental setup is shown in Fig.6.

Case i: Steady state operation. The first experimental case is the steady state operation. From Fig.7, it can be seen that, the line currents waveforms are more quasi-sinusoidal. The active power is maintained constant and very close to the reference value and the reactive power is zero on average value. Good regulation of the instantaneous powers and the decoupling is perfect and successfully achieved. The proposed control strategy operates in unity power factor (UPF)

condition. As a result, the line currents are very close to sine wave with THD=3.2%.

Case ii: transient operation. In the applications of renewable power generation systems, the required active power references for the grid-connected voltage source inverter may also be variable. In this sense, the adopted control methods should guarantee that the actual values should possess the ability of tracking their imposed references as closely as possible. In order to examine the performance of the proposed DPC in transient state, the active power command is increased in the experimental test shown in Fig. 8. After a very short transient, the instantaneous active power is maintained close to its new reference with acceptable approximation and stability. The instantaneous reactive power is of null average value. From this figure, the proposed method ensures a decoupled control of instantaneous powers in transient case.

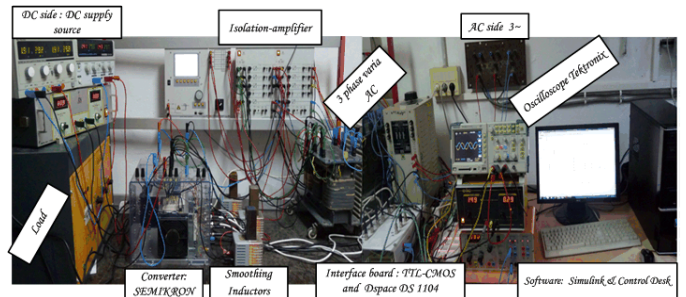
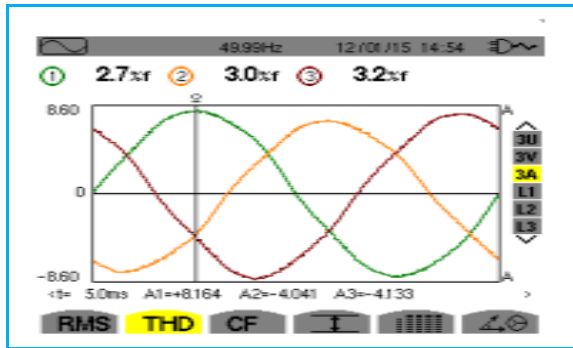
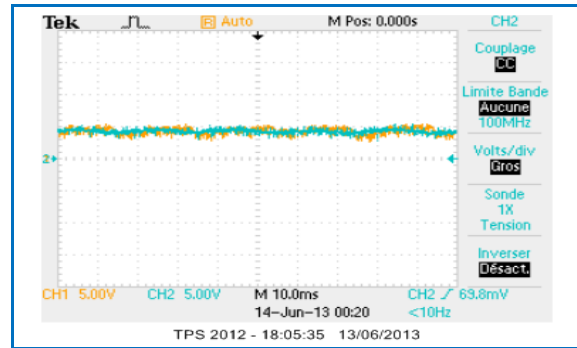

Fig. 6 A photograph of the experimental setup laboratory



(a)



(c)

Scale of CH1 & CH2 (500W/div)

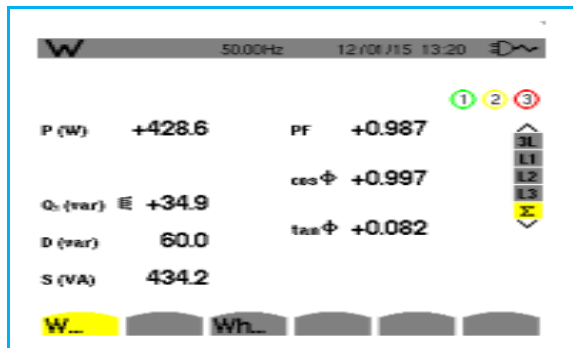

(c)

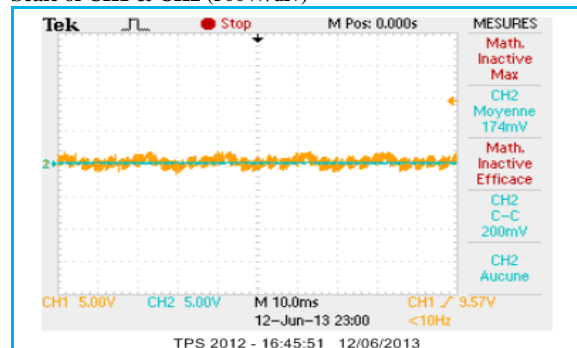

(d)

Scale of CH1 & CH2 (500Var/div)

Fig. 7 Experimental results in steady state operation at 5kHz

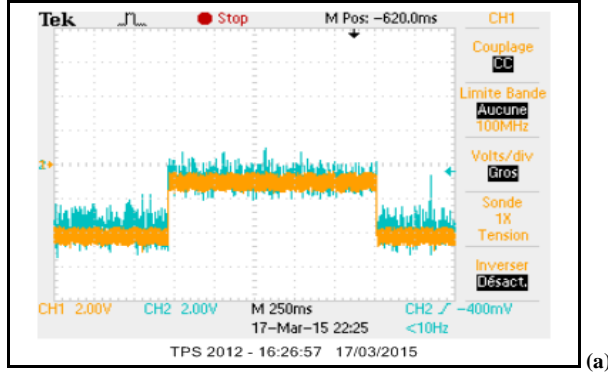

Scale of CH1 & CH2 (500W/div)

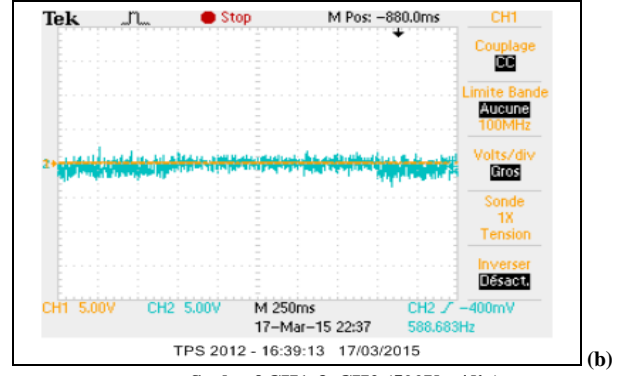

Scale of CH1 & CH2 (500Var/div)

Fig. 8 Experimental results in transient operation for steps of active power reference

VI. CONCLUSIONS

This paper describes the modeling and the control design of a variable speed wind turbine with an induction generator. The methods controls of power electronics converter are examined in several cases of simulation and experimental. The purpose in controlling the power electronics interface is to ensure a continuous power generation from zero to the highest turbine speed is possible and managed the power flow in order to inject a current with fewer harmonic.

From the results of the experimental and simulation study, the proposed control strategies guarantees the extract of maximum power and the security of turbine with power generation to the highest turbine speed. Other control objectives are accomplished it's the operation in decoupled instantaneous powers for the steady state and transient cases and a low level of total current harmonic.

APPENDIX

TABLE I. INDUCTION MACHINE PARAMETERS

Parameters	value
Rated power (kW)	300
Machine rated speed (tr/mn)	1515
Number of pole pairs	2
Stator resistance ($m\Omega$)	6.3
Rotor resistance ($m\Omega$)	4.8
Stator Inductance (mH)	11.8

TABLE III. WIND TURBINE PARAMETERS

Parameters	value
Rated power (kW)	300
Optimal power coefficient	0.475
Optimal tip speed ratio	8.1
Turbine radius (m)	14
Nominal wind speed (m/s)	12
Minimum wind speed (m/s)	4
Gear box	1/23
Equivalent Moment of inertia ($kg.m^2$)	50

TABLE IIIII. PARAMETERS OF THE TESTED VOLTAGE SOURCE INVERTER SYSTEM

Parameters	Value
Rated power	460 W
Line to line voltage	75 V
DC bus voltage	120 V
Filter inductance	12 Mh
Filter resistance	0.6 Ω
DC link capacitor (μF)	1100
Positive gains (μ_p, μ_q)	100
Control gains (σ_p, σ_q)	5000
Switching Frequency	5kHz
Sampling frequency of dSPACE	16kHz

NOMENCLATURE

- R_g, L_g : Line inductance and resistance.
- $u_{g\alpha}, u_{g\beta}$: Grid voltages in (α, β) reference frame.
- $v_{g\alpha}, v_{g\beta}$: Converter voltages in (α, β) reference frame.
- $i_{g\alpha}, i_{g\beta}$: Grid currents in (α, β) in reference frame.
- ω_g : Angular frequency of grid voltage.
- V_{dc}, V_{dc}^* : Measured and set value of dc bus voltage
- p_g, p_g^* : Instantaneous estimated and set value of active power.
- q_g, q_g^* : Instantaneous estimated and set value of reactive power.
- S_p, S_q : Sliding surfaces.
- μ_p, μ_q : The positive control gains.
- σ_p, σ_q : The control gains.

REFERENCES

- [1] J.M.Carrasco, L.G Franquelo, J.T Bialasiewicz , E. Galvan, "Power Electronic Systems for the Grid Integration of Renewable Energy Sources: A Survey", *IEEE Trans. Ind. Electron.*, 53, p.p 1002 – 1016, 2006.
- [2] Z.Chen, I.M.Guerrero and F.Blaabjerg: "A review of the State of the Art of Power Electronics for Wind Turbines", *IEEE Trans On Power Electronics*, 24, p.p 1859 – 1875, 2009.
- [3] W. Qiao, X. Yang, and X. Gong, "Wind Speed and Rotor Position Sensorless Control for Direct-Drive PMG Wind Turbines," *IEEE Trans. Industry Appl*, 48, p.p 3-11, 2012.
- [4] N. Namjoo, F. Abbasi, F. Hassanzadeh, H. Asrari and A. Hajizadeh, "A new hybrid control method for controlling back-to-back converter in permanent magnet synchronous generator wind turbines," *J. Renewable Sustainable Energy* 6 , 033133 , 2014.
- [5] M.M. Amin, O.A . Mohammed, "Development of High-Performance Grid-Connected Wind Energy Conversion System for Optimum Utilization of Variable Speed Wind Turbines", *Sustainable Energy, IEEE Transactions* 2, p.p 235- 245, 2011.
- [6] Z.Elhassanl, T. Yi and Li.Yang, "Comparative study of voltage oriented and frequency coordinated control of grid connected doubly fed induction generator," *J. Renewable Sustainable Energy* 6, 023120, 2014.
- [7] M. Monfared, H. Rastegar, "Design and experimental verification of a dead beat power control strategy for low cost three phase PWM converters," *International Journal of Electrical Power & Energy Systems*, 42, p.p 418- 425, 2012.
- [8] M. V. Kazemi, A. S. Yazdankhah, H. M. Kojabadi, "Direct power control of DFIG based on discrete space vector modulation," *Renewable Energy* Vol 35, p.p 1033–1042, 2010.
- [9] B. Bouaziz, F. Bacha and M.Gasmi, "A Sliding Mode approach into Constant Switching Frequency Direct Power Control of a Grid Connected Voltage Source Converter". *International Journal on Electrical Engineering and Informatics*, Vol 7, N° 1, March 2015.
- [10] J. Hu, H. Nian, B. Hu, Yikang He, and Z. Q. Zhu, "Direct Active and Reactive Power Regulation of DFIG Using Sliding-Mode Control Approach," *IEEE Trans. Energy. Conv*, Vol 25, p.p 1028-1039, 2010.
- [11] V.N. Pande, U.M. Mate, Shailaja Kurode, "Discrete sliding mode control strategy for direct real and reactive power regulation of wind driven DFIG," *Electric Power Systems Research*,100, p.p 73–81, 2013.
- [12] J.A. Restrepo, J.M. Aller, J.C. Viola, A. Bueno, T.G. Habetler, "Optimum Space Vector Computation Technique for Direct Power Control", *IEEE Trans on Power Electronics*, 24, p.p 1637-1645, 2009.
- [13] J.Hu, L. Shang, Y. He, Z. Q. Zhu, "Direct Active and Reactive Power Regulation of Grid-Connected DC/AC Converters Using Sliding Mode Control Approach," *IEEE Transactions on power electronics*, 26, pp. 210-222, 2011.
- [14] B. Bouaziz, F. Bacha and M. Gasmi, "Advanced control strategy based on a Sliding Mode approach". Book, LAP Lambert Academic Publishing, pp.52, August 2015.