

# Modeling and control of a permanent magnet Synchronous generator driven by a wind turbine

LADIDE Saad, HIHI Hicham and FAIT AH Khalid

Electrical Engineering Department, LGECOS, Cadi Ayyad University,  
ENSA, Av Abdelkrim khattabi BP 575, 40000, Marrakesh, Morocco  
[saad.ladide@gmail.com](mailto:saad.ladide@gmail.com), [h.hihi@uca.ma](mailto:h.hihi@uca.ma), [k.faitah@uca.ma](mailto:k.faitah@uca.ma)

**Abstract**—in this paper, we study the modeling and the control strategy of a variable-speed wind turbine using the permanent magnet synchronous generator (PMSG) driven by a wind turbine emulator. To emulate the wind turbine, an emulator based on a DC motor is used to perform as the real wind turbine when it receives the same wind profile. The generator side is controlled to obtain maximum power from the incident wind by applying the strategy of Maximum Power Point Tracking (MPPT) using optimal torque control, which will allow the PMSG to operate at an optimal speed. The model system is developed in Matlab/Simulink environment. The results of various simulations have shown the dynamic performances and effectiveness of the proposed control strategy.

**Keywords:** Field oriented control Maximum power point tracking; Permanent-magnet synchronous generator; control vector; Wind turbine emulator; Variable Speed -Wind Energy Conversion Systems.

## 1. INTRODUCTION

In a context of global energy crisis underpinned by the need for sustainable development (environmental issues, depletion of fossil resources...), the challenges of future energy require the development of renewable energy as alternative sources, clean and inexhaustible [1].

Over the last years, with technological advancement, wind power has grown rapidly and becomes the most competitive form of renewable energy [1-2]. Actually, there are many good reasons for using more wind energy on power grids. As examples, the price of wind power is therefore much more stable than the volatile prices of fossil fuel sources [3]. The marginal cost of wind energy once a station is constructed is usually less than 1-cent per kW·h. This cost has additionally reduced as wind turbine technology has improved [4].

In this context, Variable Speed Wind Energy Conversion Systems (VS-WECS) are considered the famous technologies in the present wind power industry. There are many several advantages for using (VS-WECS), for instance the ability to operate with Maximum Power Point Tracking (MPPT) in order to extract maximum power at different wind, higher efficiency, high power quality and it can be also used to reduce aerodynamic noise and mechanical stress on VS-WECS by absorbing the wind-power fluctuations [5-6].

Permanent magnet synchronous generator (PMSG) based variable speed wind turbines have many advantages such as considered stable, secure, and they don't need a gearbox. The PMSG has an important property manifested in its self-

excitation, which allows operation at high power factor and high efficiency [7-9].

Several works that are made preoccupy only the modeling and control of the generator side, without taking into account the emulation of the turbine. In our perspective this idea will focus on emulating the turbine by a DC motor to arrive to interconnect and control complete system (Wind turbine and PMSG).

This work has, three main objectives, the first is realization of the wind turbine emulator DC motor in order to emulate the behavior of a real variable speed wind turbine, the second is realization of extracting maximum power point technique, and third is controlling PMSG wind energy generation system by using FOC strategy.

To achieve that, we chose one of the best topologies that operate on variable-speed; this last enables the turbine to operate at its maximum power coefficient over a wide range of wind speeds.

The PMSG is connected to the DC bus via an AC-DC converter; this converter allows the control of the PMSG to track the maximum power.

Comprehensive models of the WECS considering system dynamics, and control actions are presented in MATLAB/SIMULINK environment.

## 2. WIND TURBINE MODEL

The amount of power captured by the wind turbine (power delivered by the rotor) [10-11] is given by:

$$P_t = \frac{\rho \cdot \pi \cdot R_t^2 \cdot C_p(\lambda, \beta) \cdot V^3}{2} \quad (1)$$

Where  $\rho$  the air density (kg/m<sup>3</sup>),  $R_t$  is the blade length (m),  $V$  is wind speed (m/s) and  $C_p$  is the power coefficient. The value of  $C_p$  is dependent on the tip speed ratio ( $\lambda$ ) and the blades pitch angle ( $\beta$ ).

The blades pitch angle is adjusted by the embedded pitch controllers and depends on the type and operating condition of the wind turbine.

In the literature, approximate expression of the power factor  $C_p$  [12] for wind turbines with variable speed is proposed in (2).

$$C_p(\lambda, \beta) = 0.73 \cdot \left( \frac{151}{\lambda_i} - 0.58 \cdot \beta - 0.002 \cdot \beta^{2.14} - 13.2 \right) \cdot e^{-18.4 / \lambda_i} \quad (2)$$

With: 
$$\lambda_i = \frac{1}{\frac{1}{\lambda - 0.02\beta} + \frac{0.003}{\beta^3 + 1}}$$

Fig.1 shows the variation of  $C_p$  as a function of  $\lambda$ , where we see that the maximum value of  $C_p = 0.4366$  is achieved for

$\lambda_{opt} = 6.6$  and for  $\beta=0$ .

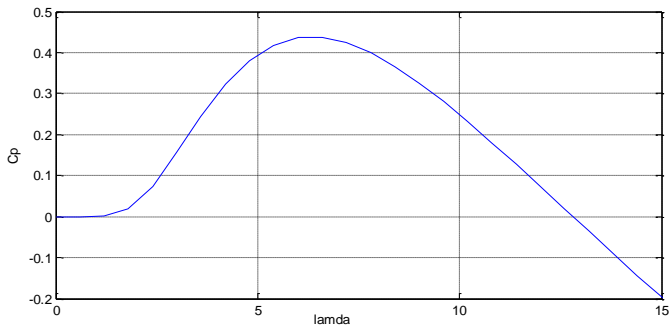

Figure 1. Characteristics of power coefficient.

In order to maintain the power coefficient at its maximum we use the MPPT control, the results simulation of this strategy control is shown in Fig.3 and 4.

### 3. MPPT CONTROL

The objective of the (MPPT) strategy is to maintain the coefficient of power to its maximum value in such way to extract the maximum power.

The optimal power can be generated from a variable speed wind turbine by operating the maximum power coefficient  $C_p^{opt}$ .

$$P_{t_{opt}} = \frac{\rho \cdot \pi \cdot R_t^2 \cdot C_p^{opt}(\lambda_{opt}, \beta) \cdot V^3}{2} \quad (3)$$

According to the optimal tip speed ratio  $\lambda_{opt}$  by imposing on the electromagnetic motor torque to be equal to its optimal reference value.

$$C_{em} = C_{em-ref} \quad (4)$$

The reference electromagnetic torque  $C_{em-ref}$  allows obtaining a mechanical speed of the generator equals to the reference speed  $\Omega_{ref}$  by the relation below [3].

$$C_{em-ref} = \frac{G_i(S\tau_i + 1)}{s\tau_i} (\Omega_{ref} - \Omega_{me c}) \quad (5)$$

Where  $G_i$ : proportional gain of the controller;  $\tau_i$ : time constant;  $\Omega_{ref}$ : mechanical speed reference. The complete scheme of MPPT strategy is represented in Fig.2.

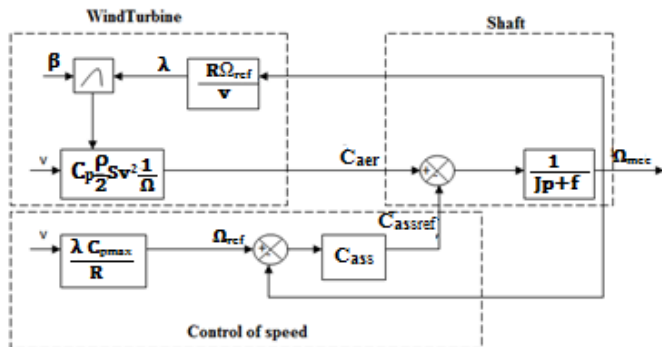

Figure 2. Diagram block of MPPT strategy.

Fig.3 show that is the coefficient of power maintained at its maximum value, after a small dynamic, regardless of the wind speed, which involves extracting of the maximum power.

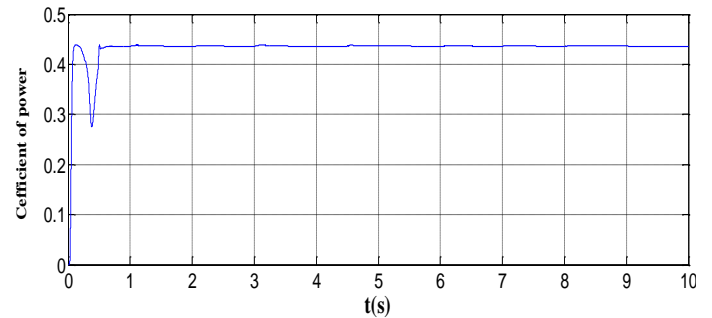

Figure 3. Coefficient of power MPPT control.

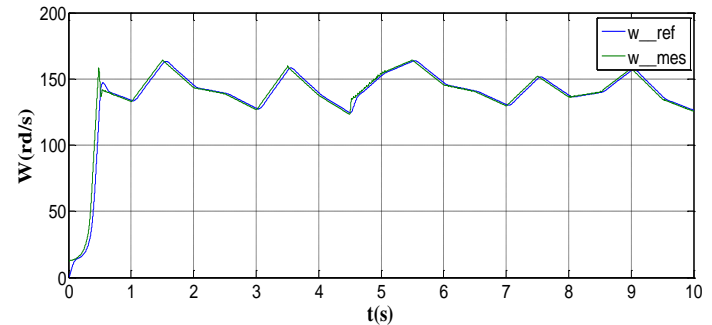

Figure 4. Mechanical speed.

### 4. TURBINE EMULATOR

The wind turbine can be emulated by DC motor rotating at a variable speed which the torque depends on the coefficient power. The block diagram of Fig.5 is introduced to develop the desired electromagnetic torque to reproduce on the mechanical shaft torque of the DC motor of the wind turbine.

The expression of the torque is obtained from (6) and from the coefficient of power curve shown in Figure 1. The block  $v(t)$  is an arbitrary signal varying between 9m/s and 14m/s.

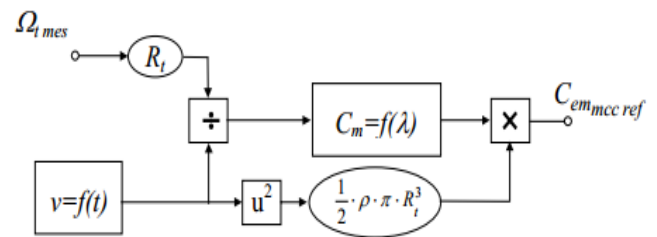

Figure 5. Emulator of wind torque.

DC motor and PMSG mechanically coupled, have different characteristics which need to regulate the excitation of the DC motor current, to reduce the flow produced by the inductor.

#### 4.1 Excitation current

From equation  $E = K_t * I_e * \Omega$  the current reference torque is expressed as: 
$$I_{eref} = \frac{E_{nom}}{K_t * \Omega} \quad (6)$$

#### 4.2 Armature current

The current reference  $I_{eref}$  is obtained from  $E = K_t * I_e * \Omega$ , this current is given by:

$$i_{iref} = \frac{C_{em\_ref}}{K_t \cdot i_{eref}} \quad (7)$$

The chosen controllers are a PI whose transfer functions are:

$$C_{ie}(p) = K_e \cdot \frac{1 + \tau_e \cdot p}{\tau_e \cdot p}; \quad (8) \quad C_i(p) = K_{fi} \cdot \frac{1 + \tau_i \cdot p}{\tau_i \cdot p} \quad (9)$$

Where  $\tau_e = \frac{L_e}{R_e}$  et  $K_e = \frac{1}{R_e}$  (10)  $\tau_i = \frac{L_i}{R_i}$  et  $K_i = \frac{1}{R_i}$  (11)

The complete scheme of the control strategy applied to the DC motor is represented in Figure 6.

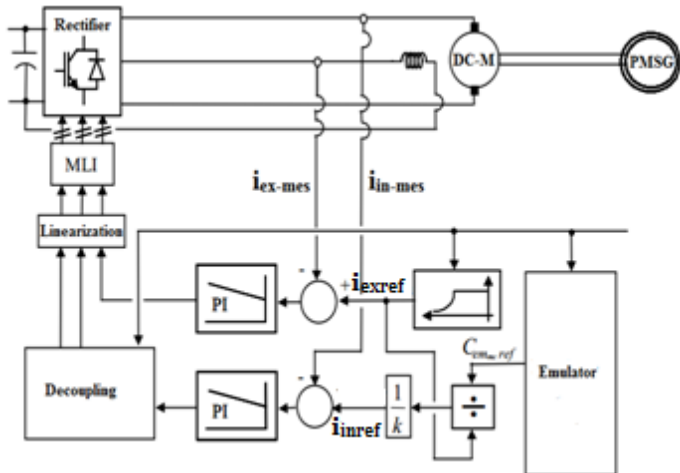

Figure 6. Schematic of control strategy for DC motor.

## 5. MODELING AND CONTROL OF THE PMSG SIDE-CONVERTER

Modeling machines is essential both for the designer and for the automation. It is generally used for the analysis of system behavior. The alternating current machines are generally modeled by nonlinear equations (differential equations). This nonlinearity is due to inductance and dynamic coefficients of the equations dependent rotor position and time. A transformation of park is necessary to simplify the model (reducing the number of equations).

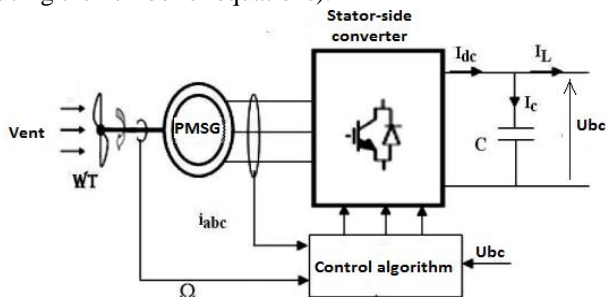

Figure 7. Schematic of the generator side.

The Electrical model of a PMSG is usually expressed in the rotating reference frame d-q as follows [13]:

$$\begin{cases} V_{sd} = -R_s \cdot i_{sd} - L_s \frac{di_{sd}}{dt} + \omega_r \cdot L_s \cdot i_{sq} \\ V_{sq} = -R_s \cdot i_{sq} - L_s \frac{di_{sq}}{dt} - \omega_r \cdot L_s \cdot i_{sd} + \omega_r \cdot \Psi_f \end{cases} \quad (12)$$

Where  $V_{sd}$ ,  $V_{sq}$ : d-q axis stator voltage;  $i_{sd}$ ,  $i_{sq}$ : d-q axis stator current;  $L_s$ : stator inductance;  $R_s$ : stator resistance ;  $\omega$ : electric pulsation;  $\Psi_f$ : magnetic flux.

The torque is given by:

$$C_{em} = \frac{3}{2} \cdot P \cdot [(L_d - L_q) \cdot i_{sd} \cdot i_{sq} + i_{sq} \cdot \Psi_f] \quad (14)$$

Where  $L_d$ ,  $L_q$  are the two axes machine inductances;  $P$  is the number of pole pairs.

Among the strategies applied to vector control a synchronous machine, considered more famous, which is to impose a reference  $i_{sd}$  direct current to zero [14]. The expression (12) of the electromagnetic torque is reduced to (13). The latter is adjusted by varying the quadrature current  $i_{sq}$ .

$$C_{em} = \frac{3}{2} \cdot P \cdot i_{sq} \cdot \Psi_f \quad (15)$$

Reference value in the q-axis machine  $i_{sq\_ref}$ , is obtained by the electromagnetic torque reference  $C_{em\_ref}$  given by:

$$i_{sq\_ref} = \frac{3}{2} \cdot \frac{C_{em\_ref}}{\Psi_f \cdot P} \quad (16)$$

### 5.1 Synthesis correctors

For torque control is proposed to implement two controllers in the command structure. Correctors currents will be adjusted in the same manner as transfer functions on both axes are the same for the machine without salience (smooth pole). So the parameters of the two controllers being the same (Fig. 8).

From equation (12) and (13), the transfer function of the machine can be written as:

$$G_s(p) = \frac{1}{R_s + L_s \cdot p} = \frac{1}{R_s} \cdot \frac{1}{1 + \tau_i \cdot p} \quad (17)$$

Where  $\tau_i = \frac{L_s}{R_s}$  is an electrical time constant. The transfer function of the selected PI is given by:

$$C_s(p) = G_i \cdot \frac{1 + \tau_i \cdot p}{\tau_i \cdot p} \quad (18)$$

It is considered that the current measurement in our study is perfect and without delay therefore:

The transfer function of the closed loop is then given by:

$$F_{tbf}(s) = \frac{i_{sd}}{i_{sd\_ref}} = \frac{i_{sq}}{i_{sq\_ref}} = \frac{1}{\frac{L_s}{G_i} s + 1} \quad (19)$$

For the first order the response time to 5% is given by:  
 $T_r = 3 \cdot \frac{L_s}{G_i}$  Hence  $G_i = \frac{L_s}{T_r}$  (20)

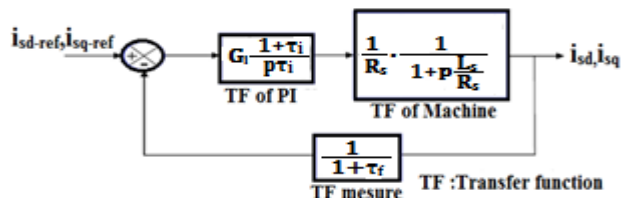

Figure 8. Regulation of ids, iqs currents.

### 5.2 Determination of current references and control signals

To determine the control of the machine we will determine in the first instance its model under Causal Ordering Graph (ICG). The Causal Ordering Graph (ICG) is a graphical tool for modeling physical and designing their control systems [15] [16]. It is a graphical representation of the energy information

passing within a system. It provides a model of a system that respects natural causality of the process and to facilitate analysis and understanding.

We can establish from equations 12, 13 the model of the synchronous machine as informational causal graph (Fig.9).

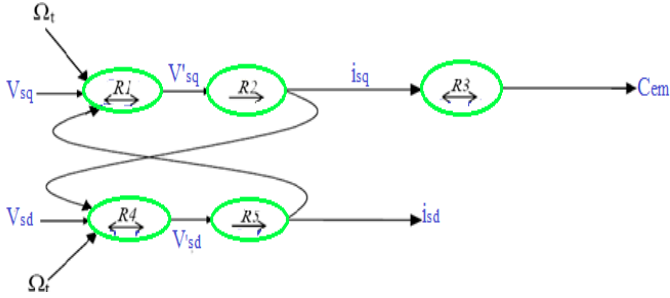

Figure 9. IGC modeling of PMSG.

Designing a controller based on a preliminary analysis of the dependencies between variables in controlling and sizes of control. The graphs informational approach is a valuable aid in this process. The Fig.10 shows the control of the PMSG, this control can be deduced by inverting its IGC model.

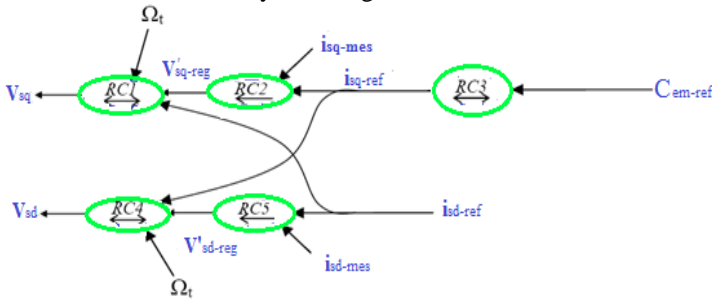

Figure 10. IGC control of PMSG.

Table 1 summarizes all of the relations that exist, C1 and C2 are the controllers of current loops.

TABLE I. EQUATIONS IGC CONTROL OF PMSG

Rci	Relation
RC1	$V_{sq-reg} = V'_{sq-reg} + L_s \cdot P \cdot \Omega_t \cdot i_{sd} + \Psi_f \cdot P \cdot \Omega_t$
RC2	$V'_{sq-reg} = C1(i_{sq-ref} - i_{sq-mes})$
RC3	$i_{sq-ref} = \frac{C_{em-ref}}{P \cdot \Psi_f}$
RC4	$V_{sd-reg} = V'_{sd-reg} - L_s \cdot P \cdot \Omega_t \cdot i_{sq-ref}$
RC5	$V'_{sd-reg} = C2(i_{sd-ref} - i_{sd-mes})$

Based on IGC Fig.10 and the table 1 we can deduce the block diagram of the control of the machine the latter is represented in Fig.11a,b.

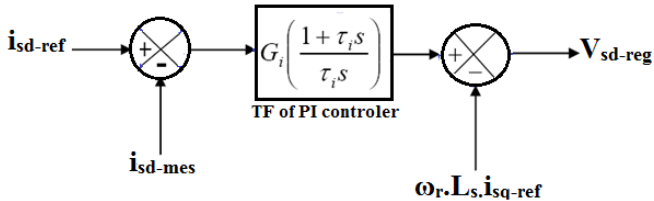

Figure 11. a Determination of the voltage Vsd-reg.

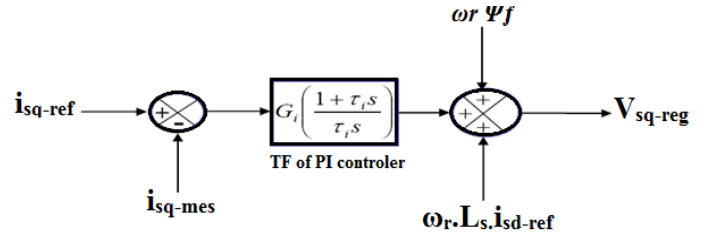

Figure.11b Determination of the voltage Vsqr-reg.

After having determined the voltage adjustments, it remains to determine the control signals applied to the converter.

## 6. MODEL OF CONVERTER

We opt for a continuous model in the equivalent of Reference Park for modeling our converter. Control voltages  $u_{wd}$  et  $u_{wq}$  will be as follows:

$$u_{wd} = 2 * \frac{v_{sd-reg}}{u_{bc}} \quad (21) \quad u_{wq} = 2 * \frac{v_{sq-reg}}{u_{bc}} \quad (22)$$

The complete scheme of the vector control strategy applied to the stator-side converter is represented in Fig. 12.

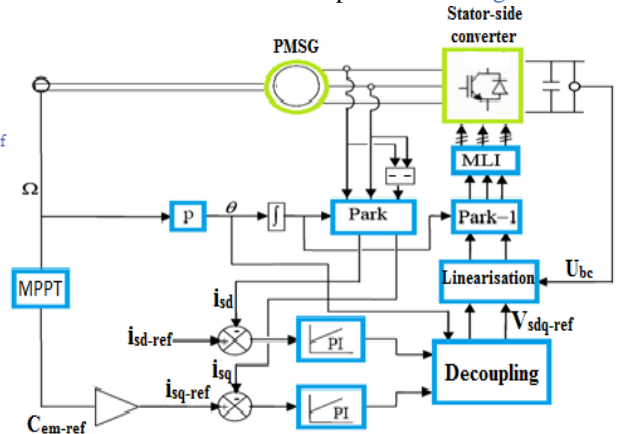

Figure 12. Schematic of the vector control strategy implemented in the stator-side converter.

## 7. SIMULATION RESULTS

Using the electrical parameters of the machine (see Appendix), the reference voltage at the output of rectifier is taken as 1500 V. The simulation results of control strategies applied to the PMSG of is built using Matlab/Simulink/Power System environment.

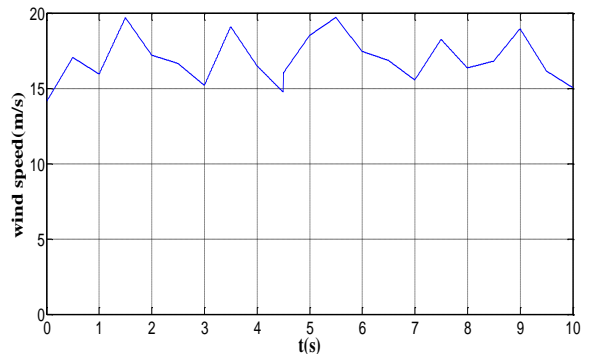

Figure 13. Wind speed.

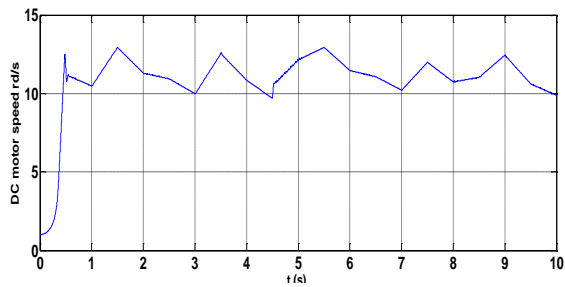

Figure 14. DC motor speed.

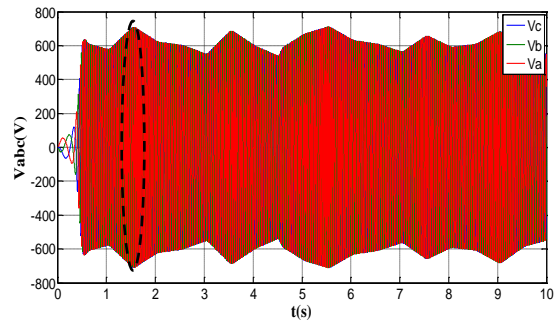

Figure 19. Three phase voltage.

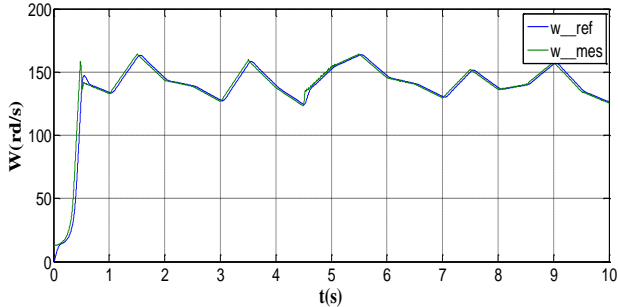

Figure 15. Mechanical (rotor) and reference speed.

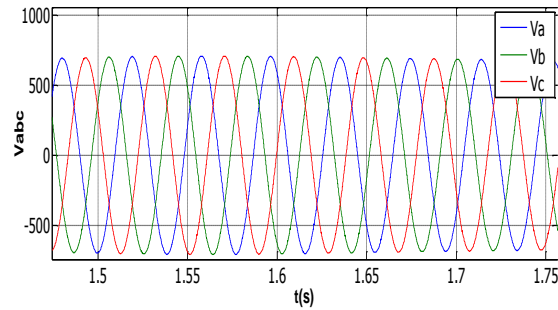

Figure 20. Zoom of three phase voltage.

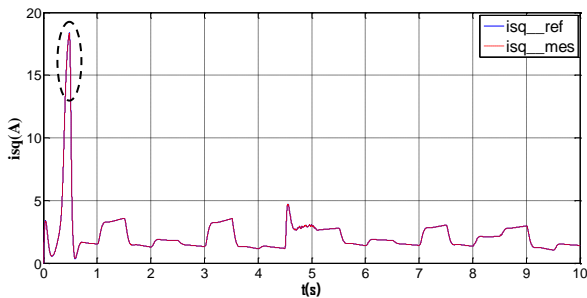

Figure 16. isq-axis current.

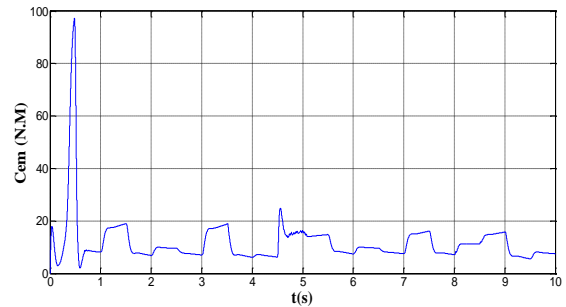

Figure 21. Electromagnetic torque.

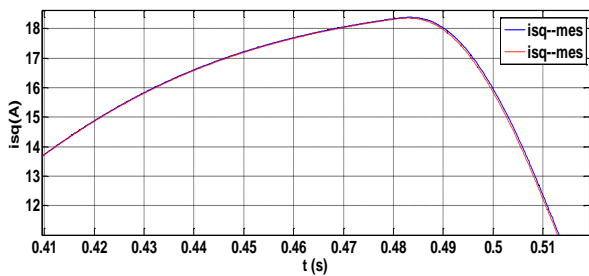

Figure 17. Zoom of isd-axis current.

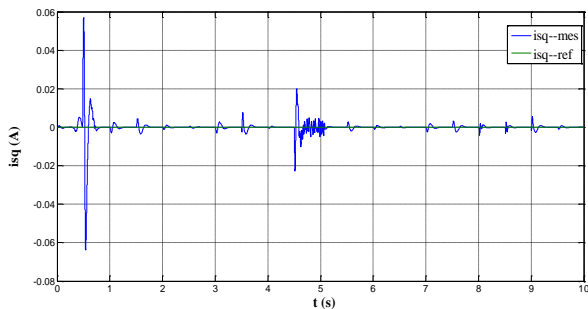

Figure 18. isd-axis current.

The Fig.13 illustrates changes in the wind speed,  $v$ , for 10 seconds. This curve is obtained by a wind profile varying between 9m/s and 12m/s.

The Fig.14 shows the evolution of the speed of the motor, controlled by a reference torque obtained according to the diagram of Fig.6. It is observed that we have a good emulation of the DC motor speed to the wind speed, which demonstrates that DC motor behaves as the wind turbine and the emulation is well achieved Fig.13 and Fig.14.

This emulation is implemented such that the DC motor speed follows homothetically changing of wind speed.

Fig.15 shows that the speed rotor follows its reference with adaptation to wind speed.

The Fig.16, Fig.17 shows that the measured quadrature  $i_{sq}$  component of stator current follows their reference.

Fig.18, also shows a good tracking of the direct current  $i_{sd}$  to its reference value that remains set to zero for our strategy of control.

The torque is regulated by the generator side converter to extract maximum power from the wind turbine by using the MPPT strategy; these results demonstrate practically the dynamic performance of the selected controllers.

We see clearly in Fig.20, 21 that the tensions  $V_{abc}$  are sinusoidal whereas its frequencies and amplitudes are proportional to the wind speed.

## 8. CONCLUSION

In this paper, the emulation of wind turbine by using DC motor was proposed in order to emulate the real profile of wind. In order to maximize the exploited power from the wind we applied MPPT control with speed controller, this method shows its simplicity and its good control.

The simulation results show the Perfect tracking responses and robust characteristics. The results show that the PMSG is suitably adapted for wind power generation systems with high performance of the speed, flux and torque with the vector control. The control strategy of PMSG has been developed by using the rotor flux oriented control. To achieve that we imposed the direct stator current to zero in order to maximize the electromagnetic torque. The validity of the control strategy is discussed and implemented using Matlab/Simulink environment.

## APPENDIX

### SIMULATION PARAMETERS

<b>Permanent Magnet Synchronous Generator</b>	
Number of Pole Pairs	10
Rated Power (kw)	6
Stator Resistance (ohm)	0.425
Stator Inductance (mh)	8.4
Rated Current (A)	12
Rated Torque (Nm)	40
<b>DC motor</b>	
Resistance (ohm)	226.7
Inductance (mh)	47.8
Armature Resistance (ohm)	1.4
Armature Inductance (mh)	0.0095
Inertia coefficient	0.0223
Electromotive coefficient	1.115
Viscous friction coefficient	0.0021
Rated armature Current (A)	14
Rated excitation Current (A)	0.65

## REFERENCES

- [1] Y Xia, K.H Ahmed, B.W. Williams, A New Maximum Power Point Tracking Technique for Permanent Magnet Synchronous Generator Based Wind Energy Conversion System, IEEE Transactions on Power Electronics, Vol. 26, No 12, pp. 3609 – 3620, December 2011.
- [2] Shao Zhang, King-Jet Tseng, D. Mahinda Vilathgamuwa, Trong Duy Nguyen and Xiao-Yu Wang, Design of a Robust Grid Interface System for PMSG-Based Wind Turbine Generators, IEEE Transactions On Industrial Electronics, Vol. 58, No 1, pp.316-328 , January 2011.
- [3] Transmission and Wind Energy: Capturing the Prevailing Winds for the Benefit of Customers- NationalGrid.
- [4] "Wind and Solar Power Systems — Design, analysis and Operation" (2nd ed., 2006), Mukund R. Patel, p. 303
- [5] Jiacheng Wang, Dewei (David) Xu, BinWu, Zhenhan Luo, A Low-Cost Rectifier Topology for Variable-Speed High-Power PMSG Wind Turbines, IEEE Transactions On Power Electronics, Vol. 26, No. 8, August 2011.
- [6] Y. Errami, M. Ouassaid, M. Maaroufi and M. Charkaoui, Direct Torque Control and MPPT Strategy of PMSG Used for Variable Speed.
- [7] Chinchilia M, Arnaltes S, Burgos J. Control of permanent-magnet generator applied to variable-speed wind-energy systems connected to the grid. IEEE Trans Energy Convers 2006;21(1).
- [8] Li S, Haskew TA, Xu L. Conventional and novel control designs for direct driven PMSG wind turbines. Electr Power Syst Res 2009;80(October):328–38.
- [9] Qiao W, Qu L, Harely RG. Control of IPM synchronous generator for maximum wind power generation considering magnetic saturation. IEEE Trans Ind Applic 2009;45(3)Wind Energy Conversion System, IEEE-International Conference On Systems and Control (ICSC), June 2012.
- [10] B. Robyns, A. Davigny, C. Saudemont, A. Ansel, V. Courtecuisse, B. François, S. Plumel, J. Deuse, « Impact de l'éolien sur le réseau de transport et la qualité de l'énergie », Actes des journées 2006 de la section Electrotechnique du Club EEA « Ouverture des marchés de l'électricité », les 15 et 16 mars 2006, Supélec, Gif-sur-Yvette, France et J3EA, Vol. 5 – Hors Série 1 (2006), DOI: 10.1051/j3ea :2006028.
- [11] J. Courault, « Production d'énergie sur ferme éolienne offshore », REE n°11, décembre 2002, pp. 80 – 89.
- [12] J.G. Sloopweg, H. Polinder and W.L. Kling, « Representing Wind Turbine Electrical Generating Systems in Fundamental Frequency Simulations », IEEE Transactions on Energy Conversion, December 2003, pp. 516-524.
- [13] J. Lesenne, F. Notelet, G. Séguier, « Introduction à l'électrotechnique approfondie », Technique et Documentation, 1981, ISBN 2-85206-089-2.
- [14] B. Robyns, Y. Fu, F. Labrique and H. Buyse, Commande Numérique des Moteurs Synchrones Aimants Permanents de Faible Puissance, Journal of Physics III-T5, No.8, August 1995.
- [15] J. P. Caron, J. P. Hautier, « Modélisation et commande de la machine asynchrone », Editions Technip, 1995, ISBN 2-7108-0683-5.
- [16] Jean Paul Hautier, Jean Faucher, Jean – Pierre Carron, « Le graphe informationnel Causal, un outil pour analyser, comprendre, représenter», Documents des journées 3EI 1999 PARIS.