

# Numerical Study of the Thermal Performance of a Direct Solar Dryer with Integrated Geothermal Water Heat Exchanger

Messaoud Sandali<sup>#1</sup>, Abdelghani Boubekri<sup>#2</sup>, Djamel Mennouche<sup>\*3</sup>

<sup>#</sup>*Mechanical Engineering Department, Kasdi Merbah University*

*Laboratoire de Développement des Energies Nouvelles et Renouvelables en Zones Arides (LENREZA), Ouargla, 30000 Algeria*

<sup>1</sup>sandalimessaoud@gmail.com

<sup>2</sup>abdelgh@gmail.com

<sup>\*</sup>*Process Engineering Department, Kasdi Merbah University*

*Laboratoire de Développement des Energies Nouvelles et Renouvelables en Zones Arides (LENREZA), Ouargla, 30000 Algeria*

<sup>3</sup>mennouche@gmail.com

**Abstract**— This paper focused on the study by numerical simulation of the thermal performance of a direct solar dryer with integration of geothermal water heat exchanger. Heat exchanger contains geothermal water of Albian. Heat exchanger with high temperature can be used as a heat source to supply the solar dryer by heat after sunset. During no-sunshine hours, the heat exchanger will provide the heat from the hot water; this is the useful heat of the circulating fluid. Therefore, the circulating fluid will provide again the heat after sunset and the drying process will continue. The climatic data used in this work were measured in Ouargla city, country of Algeria. The temperature of geothermal water in this region was found to be 343K. Numerical simulations were carried out to show the influence of the integration of the heat exchanger on the thermal performance of the solar dryer. It was found that the integration of heat exchanger improve the thermal performance of solar dryer. With integration of heat exchanger inside solar dryer, the smallest obtained value of drying air was found 327K, while the highest obtained value was found 344K. The integration of heat exchanger inside solar dryer ensure the continuity of drying process at the night and even while cloudy days.

**Keywords**— Direct solar dryer, heat exchanger, geothermal water, thermal performance, drying air temperature.

## I. INTRODUCTION

Solar energy is an important alternative source of energy. It is relatively preferred to other sources because it is free, abundant, and inexhaustible and non-pollutant in nature compared with higher prices and shortage of fossil fuels [1]. Among all renewable energy sources, such as air, wind, and water, solar energy has the least impact on the environment [2]. Food is a basic need for all human beings along with air and water. Food problem arises in most developing countries mainly due to the inability to preserve food surpluses rather than due to low production. Agricultural yields are usually more than the immediate consumption needs, resulting in wastage of food surpluses during the short harvest periods and scarcity during post-harvest period [3]

Drying is one of an important post handling process of agricultural production [4]. It is defined as the process of

removing the moisture from a product and can be implemented in two stages. In the first stage, the moisture inside the product is brought to the surface and dried in air at a constant rate as water vapor. The second stage involves a slow drying rate, and its process is related to the properties of the material to be dried [5-6]. Solar dryers circumvent some of the major disadvantages of classical drying [1]. The application of solar drying in industrial sectors can be investigated for different materials, such as biomass, brick, textile, cement, polymers, paper and allied products, and timber as well as for different processes, such as drying of porous materials, wastewater treatment, and pharmaceutical processes [5].

Solar dryers may be broadly classified into different types. Basically, four types of solar dryers have been successfully employed for the drying of horticultural produce. They are (1) direct solar dryers, (2) indirect solar dryers, (3) mixed mode solar dryers and (4) hybrid solar dryers [6]. In the direct solar drying systems, crop is exposed to sunlight directly such that it can be dehydrated. With this type of drying system a black painted heat absorbing surface is provided that can collect the sunlight and converts it into heat; the crop to be dried is placed directly on this surface. These dryers may have glass lid covers and vents to in order to increase efficiency [7].

Several works has been done in order to evaluate and to improve solar dryers such as Mennouche et al.[8] who proposed and investigated a new postharvest method using a laboratory scale direct solar dryer in order to valorize hard Deglet-nour dates. Dates samples were soaked in distilled water then dried by solar drying mean. They proposed three drying enhancements to improve the quality of date: drying under shade (DUS), drying with photovoltaic powered ventilation (DSV) and combination drying method (DCM). It was found that the drying with solar ventilation drying mode (DSV) and (DCM) were classified in favorable operating conditions needed for the studied case. The drying duration to obtain the standard moisture content (0.35 kg/kg DM) was respectively 5.25 and 8h. The combination drying method was selected as the most adequate process to realize the quality criteria and processing time.

Zarezade et al.[9] identified the effective factors and risks which may impact on the use of solar dryers. Factor analysis (FA) methodology was performed using SPSS software. Results of analysis reveal that there are six major factors and three risk types impacting the process of designing, constructing and implementation of solar dryer. It can be concluded that those six factors regarding solar dryer implementing; such as geographical situation (solar radiation and climate change), performance (the quality and speed of drying), infrastructures (private investors, sufficient knowledge, economic situation...etc), financial support (loans and government budget), cultural and political (project delivery and economic conditions), and social (farmer knowledge about solar dryers). The risks impact on the construction and implementation of solar dryers can be categorized into three major categories; financial risks, external risks, and construction risks.

Amina Benhamou et al.[10] studied the dryer performances by determining the drying curve and charge rate of drying. The dynamics of drying is monitored using an indirect solar dryer operating in forced convection, located at the UDES west of Algiers. They determined the influence of some parameters on the drying kinetics, such as the variation of the solar radiation, drying rate and variable ambient temperatures to verify the reliability of the dryer. The results showed that the increasing of drying air temperature leads to increase humidity in dryer and therefore to reduce drying time. The portion of drying air through the dryer multiple screens led to increase product water content.

S. Misha et al.[11] studied drying of Kenaf core fiber at low solar radiation using a solar solid desiccant dryer and heat exchangers. The solar energy was used to heat water using solar collector and transfer heat to the air via heat exchanger. The distribution of hot water ratio via heat exchangers 1 and 2 can be adjusted to find the optimum performance of the dryer. The system was equipped with electrical heater to maintain the temperature of hot air if the solar radiation is low. The desiccant wheel system is used as a heat source to supply hot and dry air for the drying chamber. It was found that his system reduced the drying time by 24% from 20.75h to 15.75h compared to open sun drying because it was used even in the absence of sunshine to continue the process of drying. In this system, the using percentage of solar energy is approximately 44% from the overall energy. It was found also that the drying performance increase under high solar radiation.

The results showed that the solar-assisted solid desiccant dryer can continue to be operated even at low solar radiation for kenaf core fiber drying. The improvement of drying performance was done by using of other components such as solar collector, heat exchanger, and desiccant wheel.

S.M. Shalaby et al. [12] reviewed the previous works on solar drying systems which used the phase change material as an energy storage medium. The analysis showed that the PCM reduces the heat losses and improves the system efficiency. It was concluded that such materials as carbon fibers, expanded graphite, graphite form and high thermal conductivity particles

may improve the thermal efficiency of solar energy devices employing paraffin wax as thermal energy storage medium.

In this paper, a simulation study was carried out in order to evaluate the thermal performance of a direct solar dryer in the first step, and to improve it by integration of a heat exchanger in a second step. Several simulation calculations have been performed by means of the finite volume method with a two-dimensional unsteady model implemented in the Fluent CFD software.

Therefore, the studied configuration was a laboratory scale direct solar dryer which consists of an absorber plate to absorb solar radiation, a glass cover to transmit solar radiation, insulating sidewalls to assure isolation from heat losses and heat exchanger with hot water to supply the solar dryer. In this geometry, the analysis of the convective and conductive phenomena which take place within the air gap inside solar dryer was taken into account.

## II. MODELS AND APPROXIMATION

### A. Physical Model

The geometry of the considered problem is shown in figure 1. It is a laboratory scale direct solar dryer with an integrated heat exchanger. In this study, the air enters with low temperature (ambient temperature), and its temperature get heated by the effect of the absorber plate which is very hot by the influence of solar radiations. Afterwards, the air passes through the heat exchanger which contributes the increasing of its temperature under the effect of the convention heat transfer.

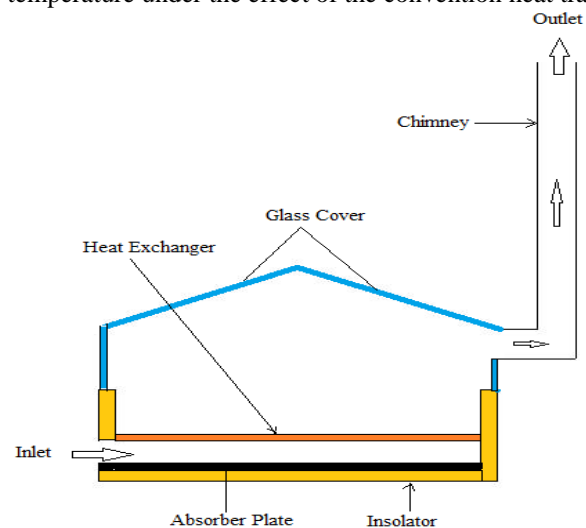

Fig. 1 Direct solar dryer with integrated heat exchanger

The geometrical dimensions of the studied problem have been chosen considering the real case of the direct solar dryer which exists at the level of *LENREZA* laboratory (university of Ouargla, Algeria) within the context of anterior works:

TABLE I  
GEOMETRICAL DIMENSIONS OF THE DIRECT SOLAR DRYER

Dimensions	Symbols	Values (m)
Solar Dryer Width	W	0.7
Solar Dryer Length	L	1
Insulation thickness	Es	0.04
Roof (glass) thickness	Eg	0.004
Absorber plate thickness	Ea	0.002
Air inlet thickness	Ei	0.1
Chimney diameter	Ec	0.1
Heat exchanger thickness	Ex	0.01
Chimney length	Lc	1

### B. Flow Model

The following equations of conservation describe the forced thermo-convective transfer inside the solar dryer

#### 1) In the Air:

Conservation of mass

$$\frac{\partial u}{\partial x} + \frac{\partial v}{\partial y} = 0 \quad (1)$$

Conservation of momentum along x and along y

$$\frac{\partial(\rho u)}{\partial t} + \text{div}(\rho Uu) = \text{div}(\mu \cdot \text{gradu}) - \frac{\partial P}{\partial x} \quad (2)$$

$$\frac{\partial(\rho v)}{\partial t} + \text{div}(\rho Uv) = \text{div}(\mu \cdot \text{gradv}) - \frac{\partial P}{\partial y} \quad (3)$$

Conservation of energy

$$\rho c \frac{\partial T}{\partial t} + \rho c \left( u \frac{\partial T}{\partial x} + v \frac{\partial T}{\partial y} \right) = \frac{\partial}{\partial x} \left( \lambda \frac{\partial T}{\partial x} \right) + \frac{\partial}{\partial y} \left( \lambda \frac{\partial T}{\partial y} \right) \quad (4)$$

U = (u, v) presents the velocity vector, ρ the density, P the pressure, μ the dynamic viscosity of the fluid.

#### 2) In the Solid Medium:

Conservation of energy:

$$\rho c \frac{\partial T}{\partial t} = \frac{\partial}{\partial x} \left( \lambda \frac{\partial T}{\partial x} \right) + \frac{\partial}{\partial y} \left( \lambda \frac{\partial T}{\partial y} \right) \quad (5)$$

### C. Daily Ambient Temperature Evolution

Fig. 2 shows the variation in the ambient temperature versus time for a well-lit day. This variation is mathematically modeled by the following empirical equation [13]:

$$T_{ao}(\tau) = \bar{T}_{ao} + \bar{T}_{ar} \cos\left(\frac{\pi}{12}(\tau - 14)\right) \quad (6)$$

$\bar{T}_{ao}$ : Average ambient temperature = 30 °C (value related on the day of April 26<sup>th</sup>, 2016 at the study site (Ouargla, Algeria))

$\bar{T}_{ar}$ : Temperature amplitude = 6 °C

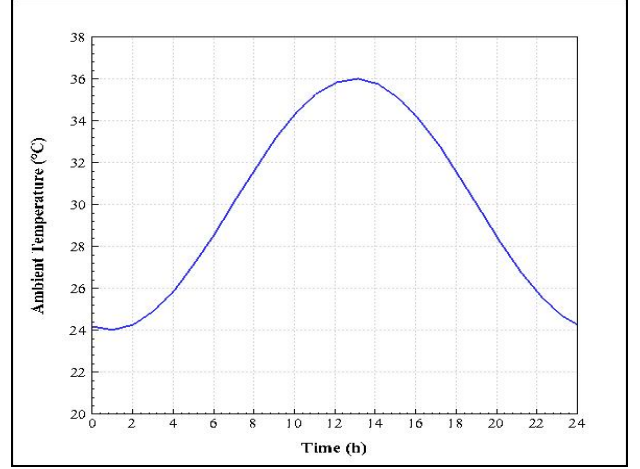

Fig. 2 Daily ambient temperature evolution

### D. Daily Solar Radiation Evolution

Figure 3 presents the variation of the solar radiation in function of time. This variation is mathematically modeled by the following empirical equation [13]

$$G_{sun}(\tau) = \hat{G}_{sun} \sin\left(\frac{\tau - a}{b - a} \pi\right), \quad a < \tau < b \quad (7)$$

$\hat{G}_{sun}$ : The maximum solar irradiation = 850 W / m<sup>2</sup> (value related on the day of April 26<sup>th</sup>, 2016 in the site of study)

$\tau$ : Time in hours

$a$ : Time of sunrise = 07: 00 am

$b$ : Time of sunset = 07: 00 pm

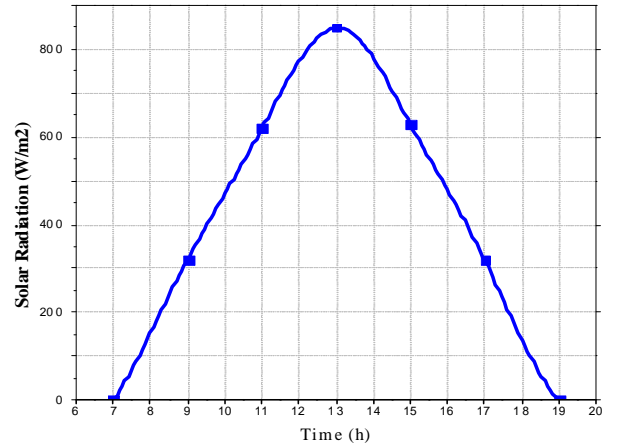

Fig. 3 Daily solar radiation evolution

## III. RESULTS AND DISCUSSION

In this part of the work, the study of direct solar dryer without integration of heat exchanger is presented in order to evaluate and to show its thermal performance before integration of heat exchanger. The contours of axial velocity and air temperature inside solar dryer are presented and discussed. As a second and principal step in this work, the study of solar dryer with integration of heat exchanger is also presented and discussed. A comparative study between the two cases of solar dryer, without and with heat exchanger, has been

done to show the effect of adding heat exchanger on the thermal performance of solar dryer.

A. Solar Dryer without Integration of Heat Exchanger

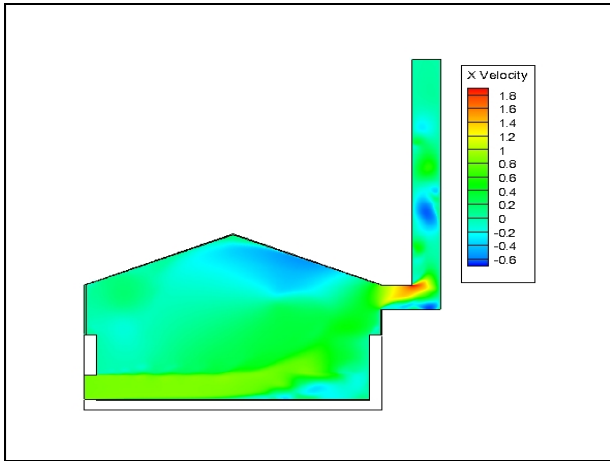
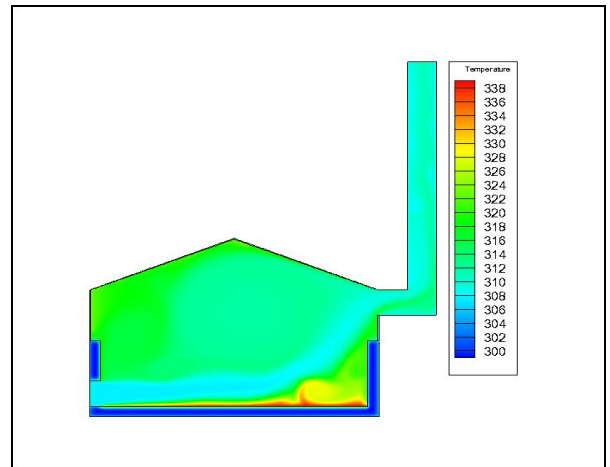
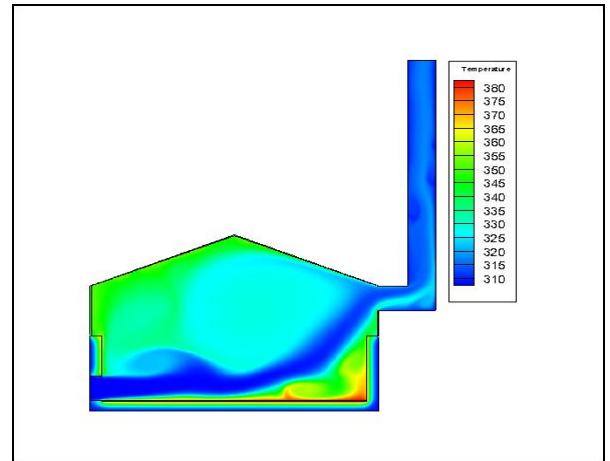

Fig. 4 Contours of axial velocity of solar dryer without heat exchanger

Fig. 4 shows that the axial velocity is almost uniform in drying region which is located in the middle of solar dryer; it is varied in the range 0.4 - 0.8 m/s. This uniformity and stability shown in the velocity of drying air makes the drying process and drying time easy to control and it can help also to keep the same final state of the same dried product. By other side, small areas appear in dark blue color indicating the presence of recirculation zones of fluid particles. These zones are generated by the presence of a singularity in the fluid flow.



10h00



13h00

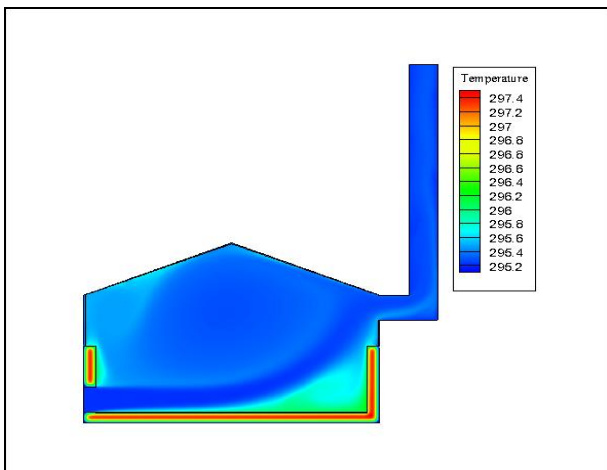

07h00

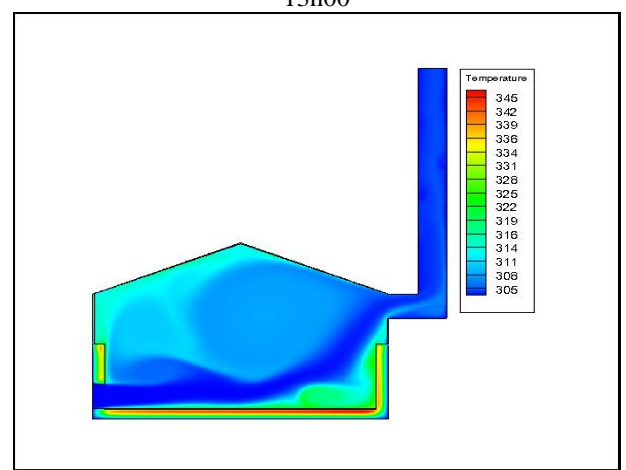

16h00

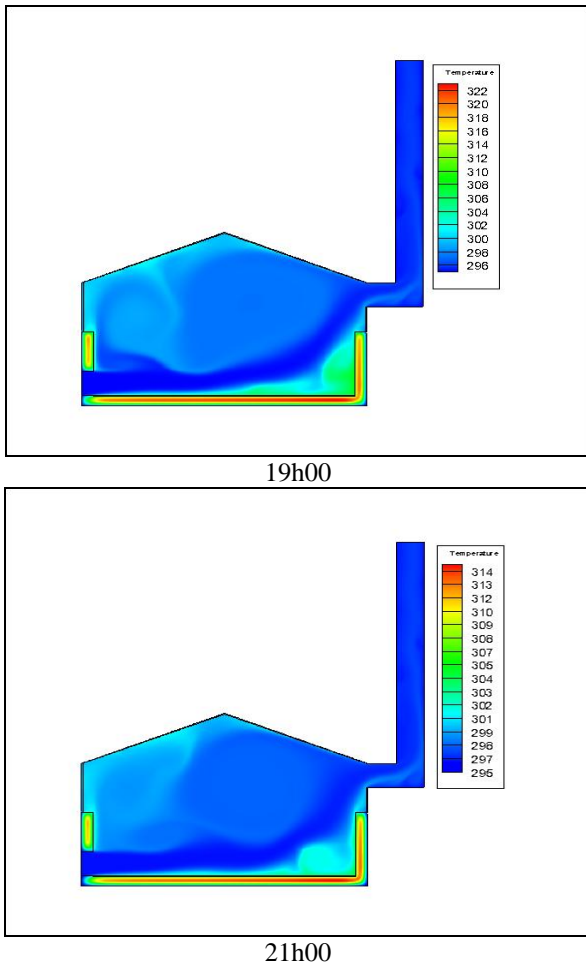

Fig. 5 Evolution of temperature counters of solar dryer without heat exchanger

Fig. 5 shows that the temperature of drying air in the middle of the solar dryer increases with the passage of time and with the increasing of solar radiation.

At first, the solar radiation at 07:00 is still very low which causes low temperatures of ambient air and absorber plate. Afterwards, the solar radiation begins to increase till reaching  $550\text{W/m}^2$ .

At 10:00, the inlet air enters with a temperature of 306 K, then its temperature increases under the effect of heat transfer by convection with the absorber plate which is generated the heat and warms the flowing air inside the solar dryer.

At 13:00, the solar radiation reaches its maximum value of  $850\text{W/m}^2$ , which allows raising the temperature of absorber plate to be 384 K, and the temperature of the drying air in the middle of solar dryer attained 329K. This was the maximum air drying temperature produced by the solar dryer.

After noon, the solar radiation starts to decrease and that brings the temperature of the absorber plate down which lead to reduce the temperature of drying air. By way of example, the temperature of the drying air in the middle of the dryer at 16:00 was 310K. After sunset, the solar radiation becomes zero, the absorber stops heating air and solar dryer becomes exhausted. On the other hand, the insulation keeps a small amount of heat and its temperature remains high compared to

the other components of the solar dryer because of its high specific heat which ensures good insulation from the thermal losses.

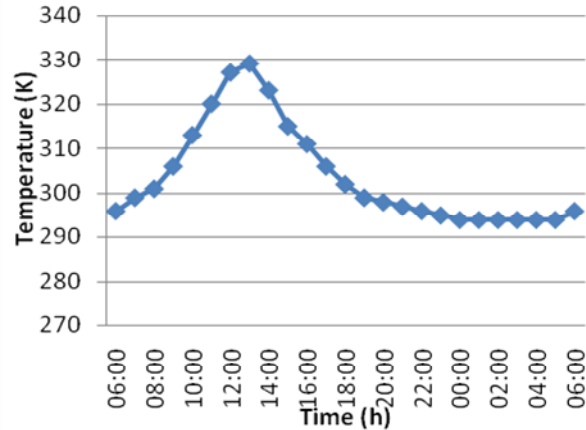

Fig. 6 Evolution of the air temperature in the middle of the solar dryer without heat exchanger

Fig. 6 shows the evolution of the air temperature in the middle of solar dryer. In the early hours of the day until 09:50 am, the air temperature in the middle remains low and did not reach the minimum sufficient temperature to start the drying operation that it is 313K. At 10:00 am, the air temperature in the middle attains the desirable value of 313K; it continues to increase until reaches its maximum of 329K at 13:00. After 13:00, the air temperature begins to decrease with passing of time; it reaches 311K at 16:00 and becomes the same as the ambient temperature after sunset.

The minimum temperature that must be maintained to make a drying operation of agricultural products is 313K. In this solar dryer, the temperature of 313K was ensured at the interval of time from 10h00 to 16h00. It was concluded that the solar dryer without integration of heat exchanger operated for just five hours.

### B. Solar Dryer with Integration of Heat Exchanger

In this part of study, the heat exchanger with geothermal water has been integrated inside solar dryer. The results are presented below:

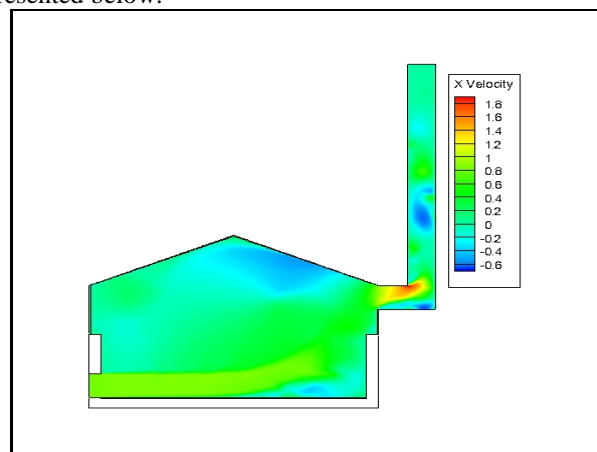

Fig. 7 Contours of axial velocity of solar dryer with integration of heat exchanger

Fig. 7 shows that the axial velocity is almost constant and homogeneous too even while the integration of the heat exchanger inside the solar dryer because it has been installed horizontally as the same direction of the air trajectory which does not involve an obstacle and which permits the passage of air easily and freely.

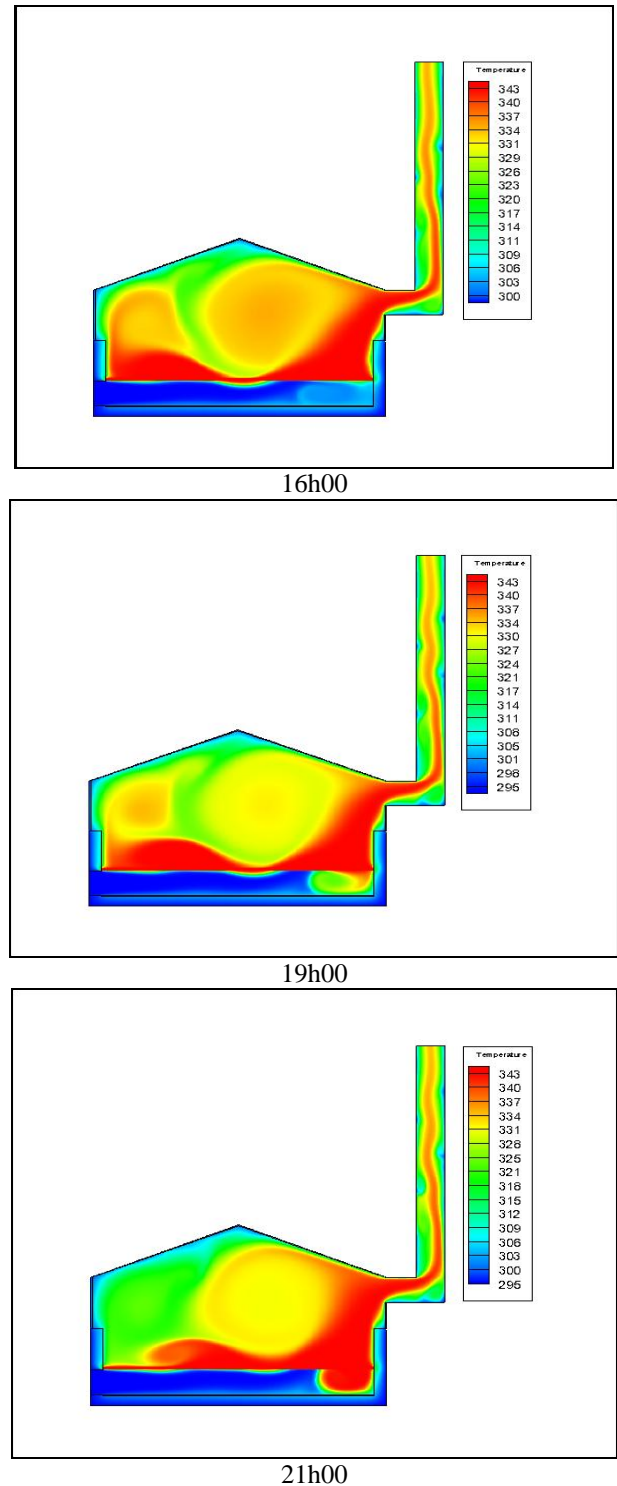
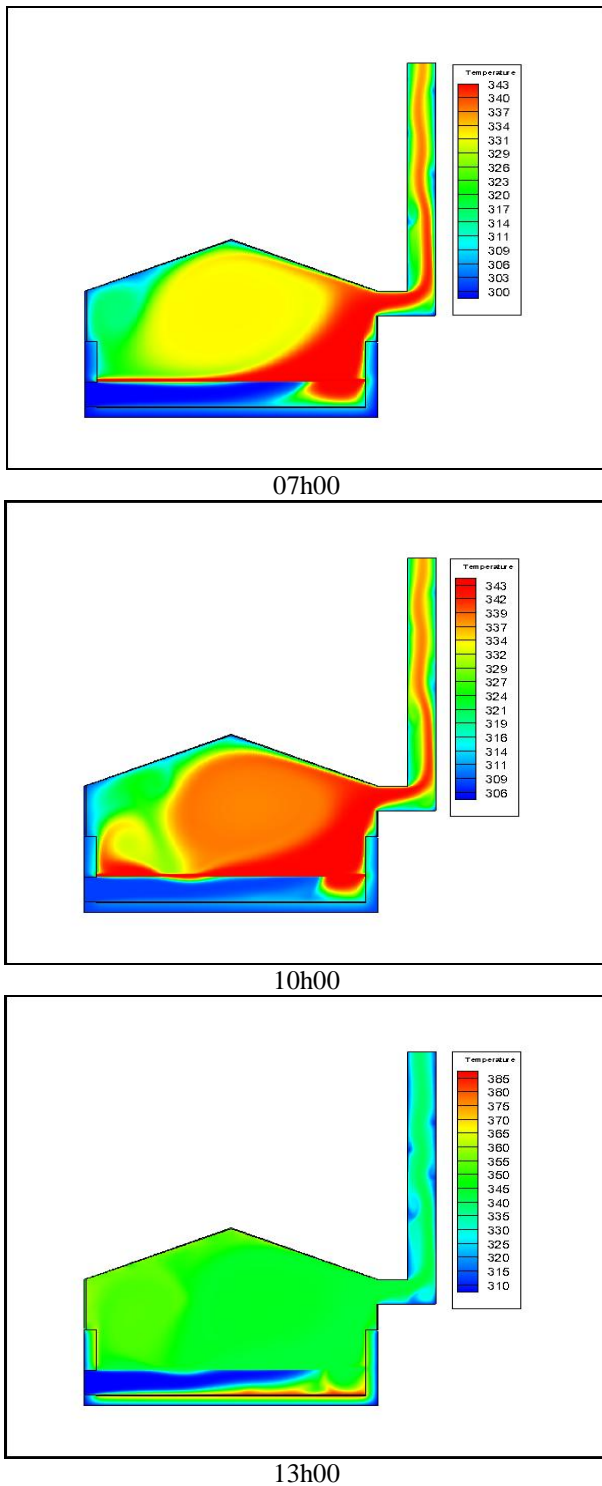

Fig. 8 Temperature fields in the solar dryer with heat exchanger

Fig. 8 shows the temperature fields inside solar dryer. At 07:00 am, it is noticed that the air enters with a low temperature 296K. After, it becomes warmer and its temperature gets increased by the effect of convection heat while passing through the heat exchanger which is realized the heat from the circulating water. The temperature of the air in

the middle of the solar dryer in this time reaches the value of 330K by the effect of the heat exchanger only.

At 10:00 am, the solar radiation increases and consequently the ambient temperature which represents the temperature of inlet air increases to become 306K. By the influence of heat exchanger and solar radiation, the temperature of air in the middle of solar dryer reaches the value of 337K.

At 13:00, the solar radiation takes its maximum value of 850W/m<sup>2</sup> where the temperature of the absorber plate reaches 385K. Air with temperature of 310K and by contact with the absorber its temperature increases more and more while passing through the heat exchanger and becomes warmer; its temperature becomes higher and reaches the maximum value in the day (344K). The presence of two sources of heat inside the solar dryer; heat exchanger and absorber plate; permit to achieve high temperature values of drying air.

After noon, the solar radiation begins to decrease with passage of time which reduces the temperature of absorber plate and consequently the decreasing of drying air temperature.

At 16h00, the air enters to the solar dryer with temperature of 300K. Afterwards, its temperature increases by contact with absorber plate to reach 336K in the middle of solar dryer by the effect of the heat exchanger.

After sunset, the solar radiation becomes zero which breaks the influence of the absorber on heating of drying air. In this case, the only source of heat that remains to be supplied the solar dryer by heat is the heat exchanger, while the temperature of the heat exchanger is fixed at 343K. The heat exchanger keeps the temperature of drying air high and sufficient value to continue the drying operation. Taking as an example, at 21:00, the temperature of the inlet air was 296K, after passing through the exchanger, its temperature increases to become 331K. This temperature is large sufficient to continue the drying operation overnight.

The existence of a second source of heat (geothermal water heat exchanger) permits to heat the air circulated inside the solar dryer even the solar radiation is zero.

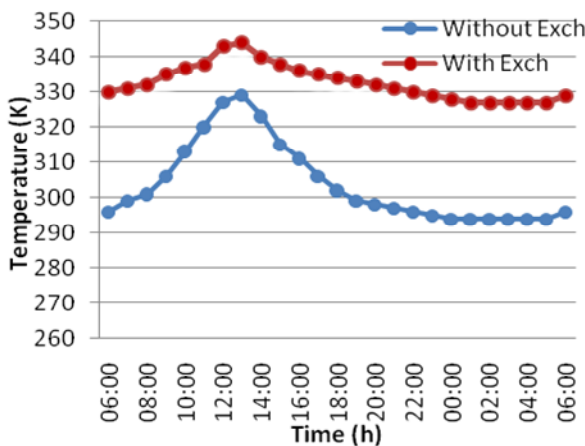

Fig. 9 Evolution of drying air temperature of solar dryer with and without heat exchanger

Fig. 9 shows the evolution of air temperature of solar dryer. In the case of integration of heat exchanger inside the solar

dryer, it is noted that the temperature of the air increases with the passage of time and with the increasing of solar radiation until reaches its maximum value (344K) at 13h00.

After noon, the solar radiation starts to decrease until becomes zero at 20:00, the temperature of drying air decrease too and reaches 331K.

After sunset and throughout the night until sunrise, the temperature of drying air remains important and almost constant with an average value of 329 K, which shows the influence of the heat exchanger on the operating of solar dryer during the night.

In order to preserve the quality of dried products, the best drying temperature range that must be maintained is 323-338K. In solar dryer with heat exchanger, we noticed that the drying air temperature reaches 338K at 11h00; and it remains very high and reached 344K until 15h00 where it becomes 338K.

For this purpose, the simulation process was carried out with breaking the functioning of the heat exchanger from 11:00 to 15:00 in order to keep the drying temperature below of 338K to preserve the quality of dried product. The new results are shown in fig. 10.

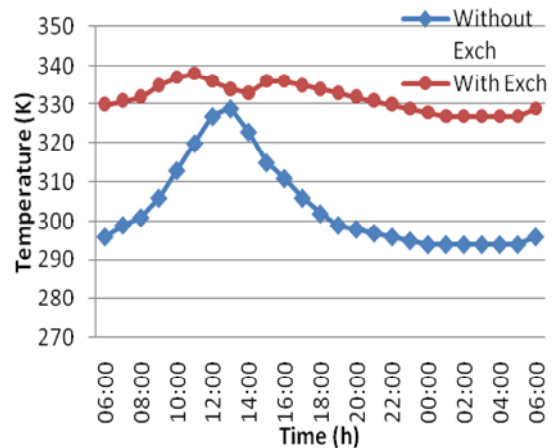

Fig. 10 Evolution of drying air temperature of solar dryer without and with breaking operating of heat exchanger from 11:00 till 15:00

Fig. 10 shows that breaking functioning of heat exchanger from 11:00 till 15:00 keep the drying temperature less than 338K during the day which allow doing drying operation without damaging the quality of products.

### C. Thermal Performance of Solar Dryer with and without Integration of Solar Dryer in a Cloudy Day

In order to show the effect of the heat exchanger on thermal performance of solar dryer in a cloudy day, simulation study was carried out in one day when a solar radiation was very low I=200W/m<sup>2</sup>.

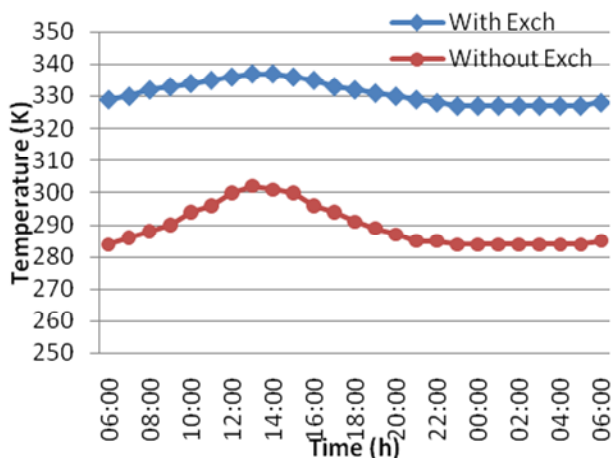

Fig. 11 Evolution of drying air temperature of solar dryer with and without heat exchanger at low solar radiation ( $I=200\text{W/m}^2$ )

Fig. 11 shows the effect of integration of heat exchanger on drying air temperature on a cloudy day. With integration of heat exchanger, the smallest value of drying air temperature was found 327K at night, while the highest value was found 337K which can ensure the drying operation even while bad climatic conditions.

#### IV. CONCLUSIONS

The presented work concerns the contribution to the study of improving the thermal performance of a direct solar dryer with integration of geothermal water heat exchanger. The heat exchanger generated the heat from the circulated hot water and react as a permanent source of heat. The obtained results in this study showed a significant improvement of the thermal behavior of solar dryer, especially after sunset. With integration of heat exchanger inside solar dryer, the smallest obtained value of drying air temperature was found 327K, while the highest obtained value was 344K. Breaking functioning of heat exchanger from 11:00 till 15:00 allowed keeping the drying temperature less than 338K during the day which allows doing drying operation without damaging the quality of products. The integration of heat exchanger inside solar dryer ensures the continuity of drying process at the night and even while cloudy days. The best temperature range of drying (323-338K) was reached and provided with integration of heat exchanger.

#### ACKNOWLEDGMENT

Authors acknowledge LENREZA laboratory for providing the suitable conditions to develop this work.

#### REFERENCES

[1] Samira Chouicha, AbdelghaniBoubekri, DjamelMennouche,Hamza Bouguetaia, Mohamed Hafed Berrbeuh. Samiha Bouhaf, Wahiba Rezzoug, "Valorization Study of Treated Deglet-Nour Dates By Solar Drying Using Three Different Solar Driers," *Energy Procedia* 50 (2014) 907 – 916

[2] Mekhilef S, Faramarzi S, Saidur R, Salam Z. "The application of solar technologies for sustainable development of agricultural sector," *Renew. Sustain. Energy Rev*2013;18:583–94.

[3] K.S. Jairaj, S.P. Singh, K. Srikant, "A review of solar dryers developed for grape drying," *Solar Energy* 83 (2009) 1698–1712

[4] F.K. Forson, M.A.A. Nazha, H. Rajakaruna, "Modelling and experimental studies on a mixed-mode natural convection solar crop-dryer," *Solar Energy* 81 (2007) 346–357.

[5] G. Pirasteh, R.Saidur, S.M.A.Rahman, N.A.Rahim, " A review on development of solar drying applications," *RenewableandSustainableEnergyReviews*31(2014)133–148

[6] A.Sangamithra, GabrielaJohnSwamy, R.SornaPrema, R.Priyavarshini, V. Chandrasekar, S.Sasikala, " An overview of a polyhouse dryer," *RenewableandSustainableEnergyReviews*40(2014)902–910

[7] Prashant Singh Chauhan, Anil Kumar, Perapong Tekasakul, "Applications of software in solar drying systems: A review," *Renewable and Sustainable Energy Reviews* 51(2015)1326–1337

[8] D. Mennouche, B. Bouchekima, A. Boubekri, S. Boughali, H. Bouguettaia, D. Bechki, " Valorization of rehydrated Deglet-Nour dates by an experimental investigation of solar drying processing method," *Energy Conversion and Management* 84 (2014) 481–487

[9] MojganZarezade, Ali Mostafaiepour, "Identifying the effective factors on implementing the solar dryers for Yazd province, Iran," *RenewableandSustainableEnergyReviews*57(2016)765–775

[10] Amina Benhamou, Fatiha Fazouane, Boumediene Benyoucef, "Simulation of solar dryer performances with forced convection experimentally proved," *Physics Procedia* 55 (2014 ) 96 – 105

[11] S. Misha, S. Mat, M.H. Ruslan, E. Salleh, K. Sopian, "Performance of a solar assisted solid desiccant dryer for kenaf core fiber drying under low solar radiation," *Solar Energy* 112 (2015) 194–204

[12] S.M. Shalaby, M.A.Bek, A.A.El-Sebaei, " Solar dryers with PCM as energy storage medium: A review," *RenewableandSustainableEnergyReviews*33(2014)110–116

[13] W. Chen, W. Liu, "Numerical analysis of heat transfer in a passive solar composite wall with porous absorber," *Applied Thermal Engineering* 28 (2008) 1251–1258.