

Modeling and Performance Analysis of RF Satellite Link System Using 16 QAM

. Kheriya. F. Alhaddar¹, Amer M. Daeri² and Amer R. Zerek³

¹Libyan Academy, School of Applied Sciences and Engineering
Electrical and Computer Engineering Department
Tripoli- Libya

E- mail kheahaddr132@gmail.com

²Zawia University. Faculty of Engineering , Computer Eng. Department
Zawia Libya

E-mail amer.daeri@zu.edu.ly

³Zawia University, Faculty of Engineering/ EE Department, Zawia, – Libya,
E-mail anas_94z@yahoo.co.uk

Abstract- In this paper, the performance of the satellite system for the C and Ku bands using 16 QAM digital modulation techniques is analyzed and investigated. The Quadrature Amplitude Modulation (QAM) is an important modulation scheme with many practical applications, including current and future wireless technologies. More spectrally efficient digital modulation scheme, such as M-ary quadrature amplitude modulation (QAM), is an attractive technique to achieve high rate transmission without increasing the bandwidth. and exact evaluation of bit error probability for M-ary QAM can be obtainable for arbitrary M. For the case of M = 16 QAM, this paper will show some practical results using tests on Matlab Simulink satellite system model for the C band at 4GHz and Ku at 8 and 12 GHz bands to investigate the effect of gain, attenuation and SNR on BER. The results showed that the BER for the C band is better than the Ku band for this model.

Keywords—Bit Error Rate (BER), M-ARY

Quadrature Amplitude Modulation (QAM),SNR, C band, Ku band

I. INTRODUCTION

Satellite communications are used to provide communication links between different points on the Earth by receiving a signal from a transmitting earth station. Satellite communications play a vital role in the global communications system. Nearly 2,000 satellites are orbiting the Earth relaying analog and digital signals carrying audio, video

and data to and from one or many locations around the world.

Especially in the recent years, personal wireless communication is getting more and more popular and is continuing to grow at an exponential rate. This growth has triggered a tremendous demand for not only higher transmission capacity, but also greater coverage area and better quality of service. This demand is being served by employing digital modulation, which provider noise immunity and robustness to channel deterioration and a better error detection and correction control. [1]

A communications satellite is an orbiting artificial earth satellite that receives a signal from a transmitting earth station, amplifies and potentially processes it, then transmits it back to a ground station. Communications information does not start and/or end in the satellite itself. The satellite is an active relay, similar to the propagation function of towers used in terrestrial microwave communications. [2]

Recent theoretical studies of communication systems show much interest in high-level modulation, such as M-ary Quadrature amplitude modulation (M-QAM), and most related works are based on the simulations. In this paper, a simulation model to study various QAM modulation

techniques is proposed. The simulation model is implemented in Matlab/Simulink.

The rest of paper is organized as follows: section II outlines the M-ARY Quadrature amplitude modulation, section III explains the QAM performance measures, section IV details simulation being performed and the results are shown in section V. Section VI gives the conclusion being drawn from this work.

II. M-ary QUADRATURE AMPLITUDE MODULATION

Quadrature amplitude modulation is the combination of amplitude shift keying and phase shift keying. Quadrature amplitude modulation is a system in which data is transferred by changing some aspect of a carrier signal, or the carrier wave, usually a sinusoid in response to a data signal.

In the case of QAM, the amplitude of two waves of the same frequency, 90° out-of-phase with each other in quadrature are changed modulated or keyed to represent the data signal.

In quadrature amplitude modulation, a signal obtained by summing the amplitude and phase modulation of a carrier signal a modulated sine and cosine waves or quadrature waves are used for the data transfer [3].

The mathematical representation of the M-ARY QAM is:

$$S_i(t) = \{a_i \cos(2\pi fct) + b_i \sin(\pi fct)\} \quad (1)$$

Where: $0 \leq t \leq T$; $i=1,2,\dots,M$

Phase modulation (analog PM) and phase-shift keying (digital PSK) can be regarded as a special case of QAM, where the magnitude of the modulating signal is a constant, with only the phase varying. This can also be extended to Frequency modulation (FM) and frequency-shift keying (FSK), for these can be regarded as a special case of phase modulation.

In a constellation diagram, constellation points are arranged in a square grid with equal horizontal and vertical spacing other configurations are possible as well.

In digital communication, as data is binary, it follows that the number of points in the grid usually will be a function of the power of 2 (2, 4, 8, 16, etc.) [1,4, 5]

III. M-QAM PERFORMANCE MEASURES

There are several parameters of QAM, which are explained some of them briefly in the following points

A. Constellation Diagram

Planetary diagrams can simulate different shapes of situations within different combinations of QAM, quadratic width formation. As the configuration order increases, the number of points in the QAM constellation increases. Figure (1) shows the constellation diagram of 16 QAM, M=16-QAM, Symbol=4bits, 2^4 bits=16

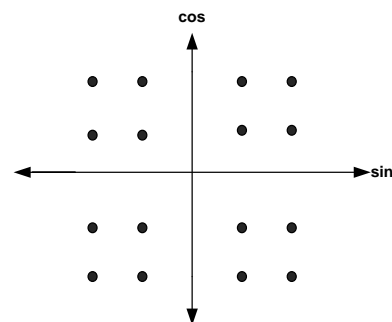

Figure (1)the constellation diagram of 16 QAM

B. Bit Error Rate Probability

The probability of error of QAM system is given by following equation.

$$P_e = \frac{2(M-1)}{M} \cdot Q \left[\sqrt{\frac{6(\text{Log}_2(M))}{(M^2-1)}} \cdot \sqrt{\frac{E_b}{N}} \right] \quad (2)$$

Where:

E_b : Bit energy.

No : Noise power.

M : Number of output levels

Bit error rate is a general performance test for digital communication systems. For RF satellite systems, BER is defined at several points on the transceiver link.

The bit errors counted are then related to the number of bits transmitted within the corresponding period, providing the bit error rate (BER).

$$\text{BER} = \frac{\text{bit errors}}{\text{transmitted bits}} \quad (3)$$

VI. 16 QAM SIMULATION

MODEL

Simulation is a technique of constructing and running a model of the real system in order to study its behavior. Also, a simulation can be defined as the process of modeling any system.

In this paper the a Matlab with Simulink V. 2016a is used to implement and simulate the RF satellite link system using the 16 QAM model to obtain the power spectra for Tx and Rx, constellation.

Figure (2) illustrates the overall outline of the basic satellite communications system. The communication system consists of several ground stations on the ground and these are connected with the satellite in space by means of free space link. The user connects to the earth station over a terrestrial network and the terrestrial network may be a telephone adapter or land station connection.

The user creates the primary band signal processed through a terrestrial network and is transferred to a satellite on the ground station. The satellite transponder consists of a large number of space transmitters, receives the radio waveform in the uplink frequency spectrum from all earth stations, amplifies these carriers and sends them back to earth stations in the downlink frequency spectrum.

To avoid interference, the downlink spectrum should differ from the uplink frequency spectrum. The signal is processed at the receiving ground station to retrieve the primary band signal, which is sent to the user via the ground station.[7]

VII. SIMULATION RESULTS

Three tests were performed after setting all the simulation parameters of the system.

The extended C band is used for uplink transmission with a frequency of 8000 MHz and 4000 MHz for downlink.

The modification used here is QAM to save the bandwidth. The extended C band is more common, due to a lower spread problem. Rain attenuation and low sky noise at the 4 GHz downlink of the C band, so it is possible to build a receiver system.

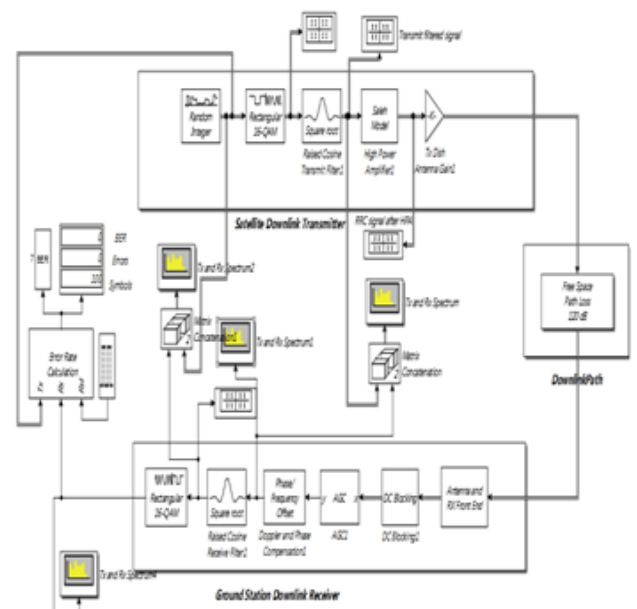
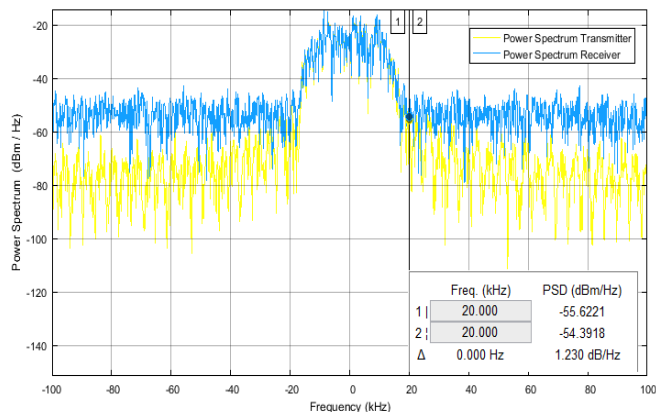

Figure (2) Simulation Model of RF Satellite

The extended Ku band was also used for uplink transmission at 8000 MHz band the downlink and its 12000 MHz band for the uplink. In the same modification, Flatten made it more problematic in terms of noise and attenuation from the C band.

Test 1 : in this test when the carrier frequency is 4000 MHz, the power spectrum of the transmitter and receiver as well to constellation diagram are achieved after setting

all the simulation parameters of the overall RF



satellite link system in 16 M-ary QAM. The achieved simulation results are shown in figure (3)

Figure (3) Transmit and Receive Spectra at the carrier frequency of 4000 MHz

In Figure (3) Spectral transmission and reception show that the transmitted spectrum signal is shown in yellow and the signal received is shown in blue. Both spectra are almost identical but some of the effects of noise, heat and attenuation caused by the signal in the space can be seen in the spectral of the received signal.

From Figure (3) it is clearly indicated that Transmitted power spectrum is (-55.6221dBm/Hz) and received power spectrum is(-54.391dBm/Hz) ,the difference between them (1.230dB/Hz).

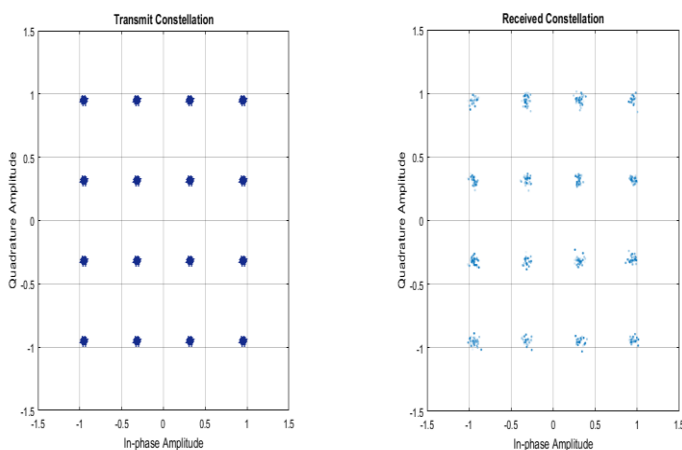

Figure (4) Transmit and Receive Constellation Diagrams

Figure (4) shows the constellation diagram of the transmitted and received signals at the 4 GHz frequency. It is quite clear from the figure the effect of noise on the received signal.

Figure (5) indicates the constellation diagrams for the transmitted signal before and after the high power amplifier. From the figure it can be seen that the effect of amplification and the improvement of the constellation at the amplifier output.

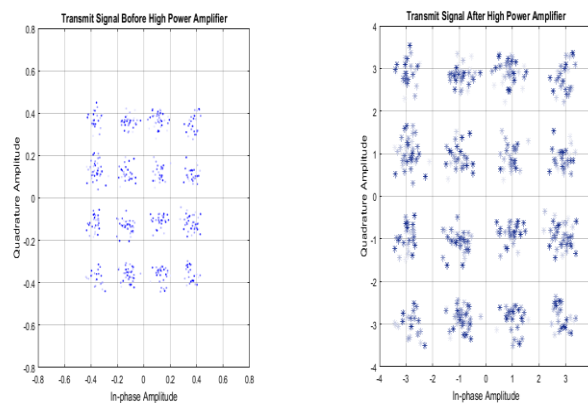

Figure (5) constellation diagram of transmitted signal before and after HPA

Test 2: in this test when the carrier frequency is 8000 MHz, the power spectrum of the transmitter and receiver are shown in figure (7)

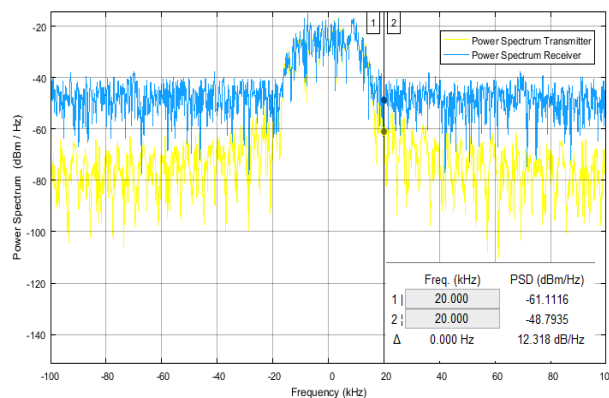

Figure (6) Transmit and Receive Spectra at the carrier frequency of 8000 MHz

In Figure (6) Spectral transmission and reception show that the transmitted spectrum signal is shown in yellow and the signal received is shown in blue. In this case it can be noted that the difference in transmission and receptions spectrum is higher

than test1, where it is 12.318 dB/Hz since the transmitted power spectrum is (-61.1116dBm/Hz) and received power spectrum is (-48.7935dBm/Hz).

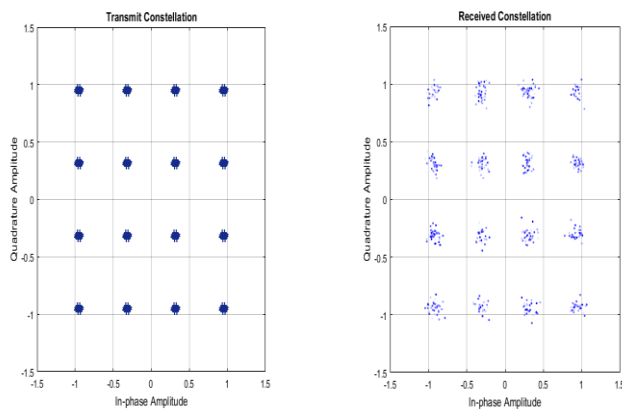

Figure (7) Transmit and Receive Constellation Diagrams

Figure (7) shows the constellation diagram of the transmitted and received signals at the 8 GHz frequency. As in the previous case the effect of noise on the received signal is very visible.

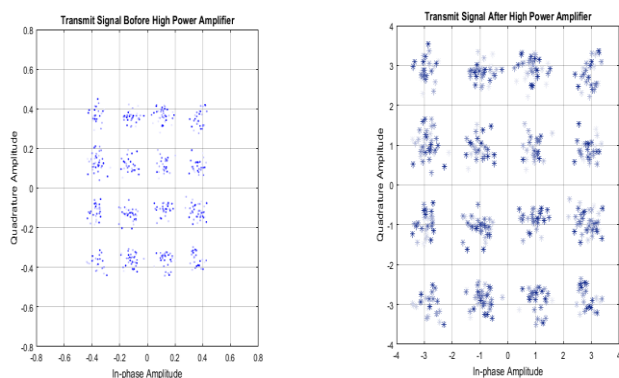

Figure (8) constellation diagram of transmitted signal before and after HPA

Figure (8) indicates the constellation diagrams for the transmitted signal before and after the high power amplifier. From the figure it can be seen that the effect of amplification and the improvement of the constellation at the amplifier output for 8 GHz KU band.

Test 3: in this test the carrier frequency is set at 12000 MHz, the power spectrum of the transmitter

and receiver were measured as indicated in figure (9)

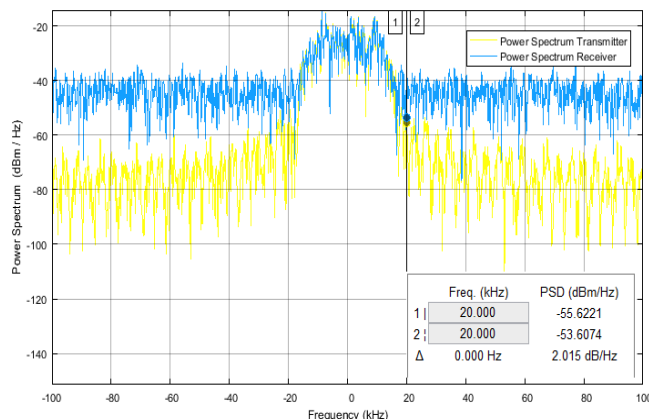

Figure (9) Transmit and Receive Spectra at the carrier frequency of 12000 MHz

Figure (9) shows the transmitted power spectrum signal and the signal of the received power spectrum. Both spectra are very close but due to some of the effects of noise, heat and attenuation the received signal power spectrum is distorted. As indicated in figure (10) the transmitted power spectrum is (-55.6221dBm/Hz), the received power spectrum is (-53.6074dBm/Hz) and the difference between them is (2.015dB/Hz).

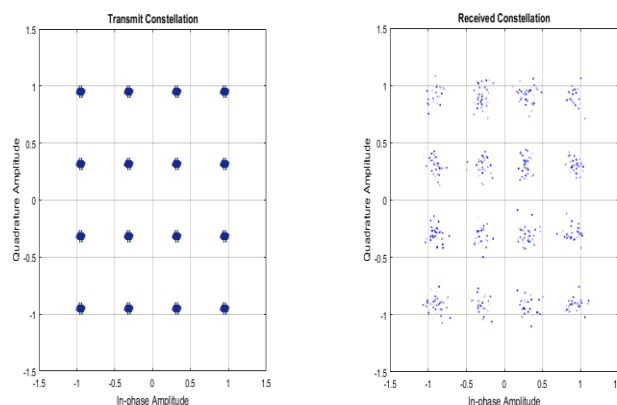
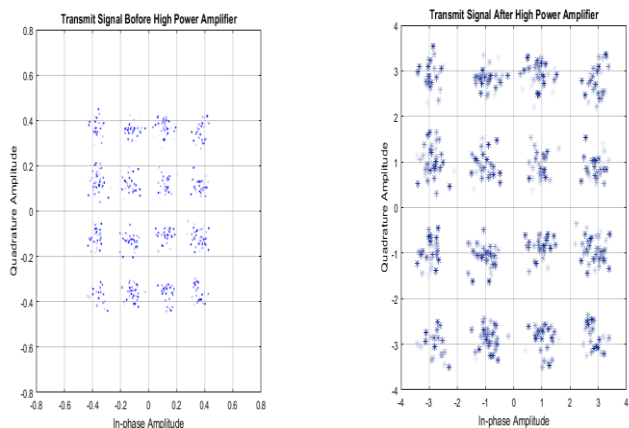

Figure (10) Transmit and Receive Constellation Diagrams at frequency of 12 GHz

Figure (10) shows the constellation diagram of the transmitted and received signals at the 4 GHz frequency. It is quite clear from the figure the effect of noise on the received signal Figure (11) indicates the constellation

diagrams for the transmitted signal before and after the high power amplifier when frequency was 12 GHz.



From the figure it can be seen that the effect of amplification and the improvement of the constellation at the amplifier output.

Figure (11) constellation diagram of transmitted signal before and after HPA at 12 GHz

The curves of Bit Error Rate variations versus Gain using 16QAM are shown in Figure.(12) ,with varying the frequency values 4000, 8000 and 12000 MHz From the results shown, it is observed that Bit Error Rate decreases as the Gain increases, but increases with carrier frequency increase.

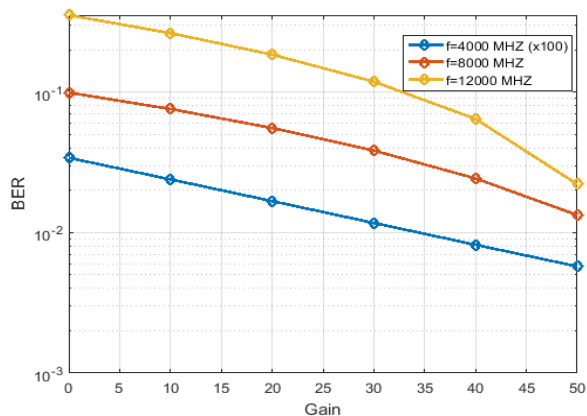

Figure.(12) The Relationship Between Bit Error rate and the Gain

The curves of Bit Error Rate variations versus attenuation using 16QAM are shown in Figure (13), with varying the frequency values 4000, 8000 and 12000 MHz, From the results shown in

plots, it is observed that Bit Error Rate decreases as the attenuation increases, although for the 4GHz frequency case the variation in BER is not significant.

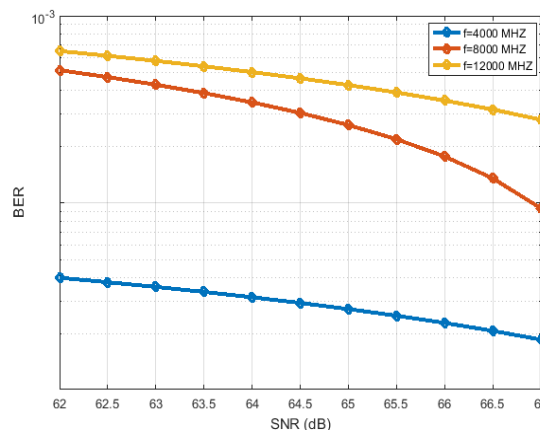

Figure.(13) The Relationship Between Bit Error rate and the Attenuation (dB)

The variation of BER when SNR was varied is shown in figure (14).

It is clearly shown in the figure that as the SNR increases the BER decreases. The amount of BER reduction is closely related to the carrier frequency being used, the higher the frequency the higher the BER. Therefore BER reduction is inversely proportional to carrier frequency. .

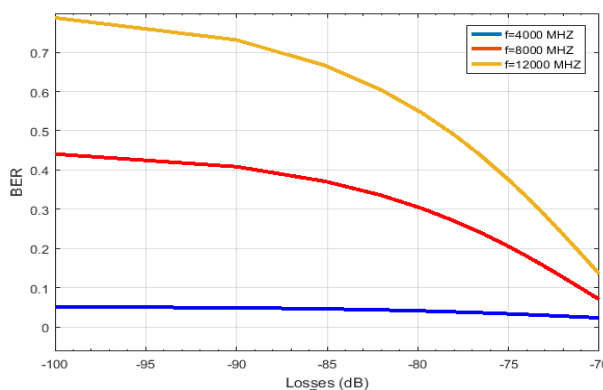

Figure.(14) The Relationship Between Bit Error rate and the SNR(dB)

VIII. CONCLUSION

The performance of the satellite system using 16 QAM digital modulation technologies in the proposed satellite system model was investigated and analyzed. The tested model performed better for the extended C band (4GHz) than the extended KU band (8 -12GHz) in terms of BER

against the system gain, the attenuation and the SNR parameters.

This means that 16 QAM modulations is better used for the C band satellite system since BER values are at a level that does not have a severe effect on the overall performance of this type of system.

REFERENCES

1. Bourdillon O. Omijeh, Ifiokabasi Eyo, "Comparative Study of Bit Error Rate of Different M-ary Modulation Techniques in AWGN Channel", American Journal of Networks and Communications,; 5(5): 82-90. 2016.
2. Loais J. Ippolito, Jr." Satellite communications Systems Engineering Atmospheric Effects, Satellite Link Design and System Performance ", Engineering Consultant and Adjunct Professor, The George Washington University, Washington DC, USA Second Edition,2017.
3. <http://www.Satellitecommunications.com> 17:30Sunday 3/3/2016.
4. P. James. "The RF Modeling of a generic Communication Satellite Trans border"
5. MIPRO. , Simulation Study of M-ARY QAM Modulation Techniques using Matlab/ Simulink,, 2017.
6. Douglas A. Cummings.(2001)."Overview of Wireless Communications Technologies", The University of Texas at Austin,10 October 2001
7. IJDPS. C-Band VSAT Data Communication System and RF Impairments. 2015.